



FORD PERFORMANCE

M-6017-A504VB 2011-2014 Coyote 5.0L Crate Engine Controls Pack INSTRUCTION SHEET

NO PART OF THIS DOCUMENT MAY BE REPRODUCED WITHOUT PRIOR AGREEMENT AND WRITTEN PERMISSION OF FORD PERFORMANCE PARTS

Please visit www.performanceparts.ford.com for the most current instruction and warranty information.

**!!! PLEASE READ ALL OF THE FOLLOWING INSTRUCTIONS CAREFULLY PRIOR TO INSTALLATION.
AT ANY TIME YOU DO NOT UNDERSTAND THE INSTRUCTIONS, PLEASE CALL THE FORD Performance
TECHLINE AT 1-800-367-3788 !!!**

Controls Pack Installation Manual 2011-2014 5.0L 4V

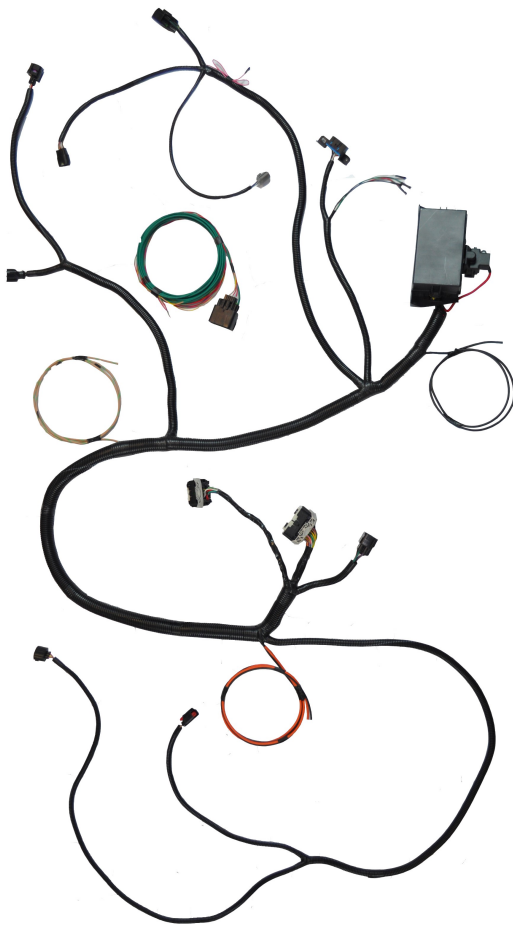

Factory Ford shop manuals are available from Helm Publications, 1-800-782-4356



FORD PERFORMANCE

M-6017-A504VB 2011-2014 Coyote 5.0L Crate Engine Controls Pack INSTRUCTION SHEET

NO PART OF THIS DOCUMENT MAY BE REPRODUCED WITHOUT PRIOR AGREEMENT AND WRITTEN PERMISSION OF FORD PERFORMANCE PARTS

TABLE OF CONTENTS

Section	Topic	Page
1.0	Introduction.....	2
2.0	Overview.....	2
3.0	Included Components.....	3-7
4.0	Tools Required.....	7
5.0	Pre-Installation of Harness and Parts.....	7
6.0	Harness Wire Colors and Connector Locations.....	8
7.0	Harness Installation.....	9
8.0	I/P Pigtail Wiring Connections.....	10
9.0	Ford Performance Power Distribution Box Installation (recommended).....	10-11
10.0	Fuel System.....	11-12
11.0	Initial Start Up.....	12
12.0	Fuses & Relays.....	13
13.0	Troubleshooting Tips.....	13
14.0	Connector Faces.....	14-15

1.0 INTRODUCTION

This kit was developed by Ford Performance to allow performance enthusiasts to easily install today's modern muscle into street rods from yesterday. We have developed this system to take the complexity and mystery out of installing a 2011-2014 Mustang Electronic Throttle Control (ETC) engine into your vehicle. The system supports manual transmission only.

NOTE: This system does not support cruise control.

2.0 OVERVIEW

This booklet provides a step by step guide for the preparation and installation of the controls pack. Please read the instructions thoroughly before starting the installation. If you have any questions, contact Ford Performance Technical Support at (800) 367-3788.

Factory Ford shop manuals are available from Helm Publications, 1-800-782-4356



FORD PERFORMANCE

M-6017-A504VB 2011-2014 Coyote 5.0L Crate Engine Controls Pack INSTRUCTION SHEET

NO PART OF THIS DOCUMENT MAY BE REPRODUCED WITHOUT PRIOR AGREEMENT AND WRITTEN PERMISSION OF FORD PERFORMANCE PARTS

3.0 COMPONENTS INCLUDED

3.1 Cowl Wiring Harness

CM-14A006-A5LD

This harness is labeled and includes all connections required to power up and run your engine equipped with a 2011-2014 factory engine harness.

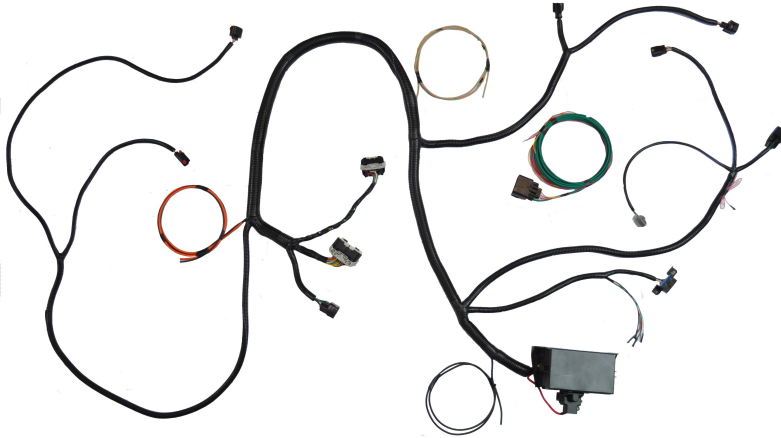

3.2 Accelerator Pedal

BR3Z-9F836-D

This pedal is required for correct electrical interface with the PCM. The engine will not operate correctly without this exact pedal.



Factory Ford shop manuals are available from Helm Publications, 1-800-782-4356



FORD PERFORMANCE

M-6017-A504VB 2011-2014 Coyote 5.0L Crate Engine Controls Pack INSTRUCTION SHEET

NO PART OF THIS DOCUMENT MAY BE REPRODUCED WITHOUT PRIOR AGREEMENT AND WRITTEN PERMISSION OF FORD PERFORMANCE PARTS

3.3 Powertrain Control Module (PCM) CM-12A650-A5LA (5.0L 4V)

Commonly referred to as the engine computer, or 'brain', this PCM is calibrated for operation with a stock BR33-9600-BC air cleaner assembly (included with this kit) and 'Return Style' fuel system as shown on page 14. The PCM is designed for under-hood mounting but may also be located in the wet cowl/wiper motor area or passenger compartment of the vehicle if desired. Wiring modifications may be required to support location of the PCM in either of these two areas. The pictures below show an example of the PCM installed in the wet cowl area.

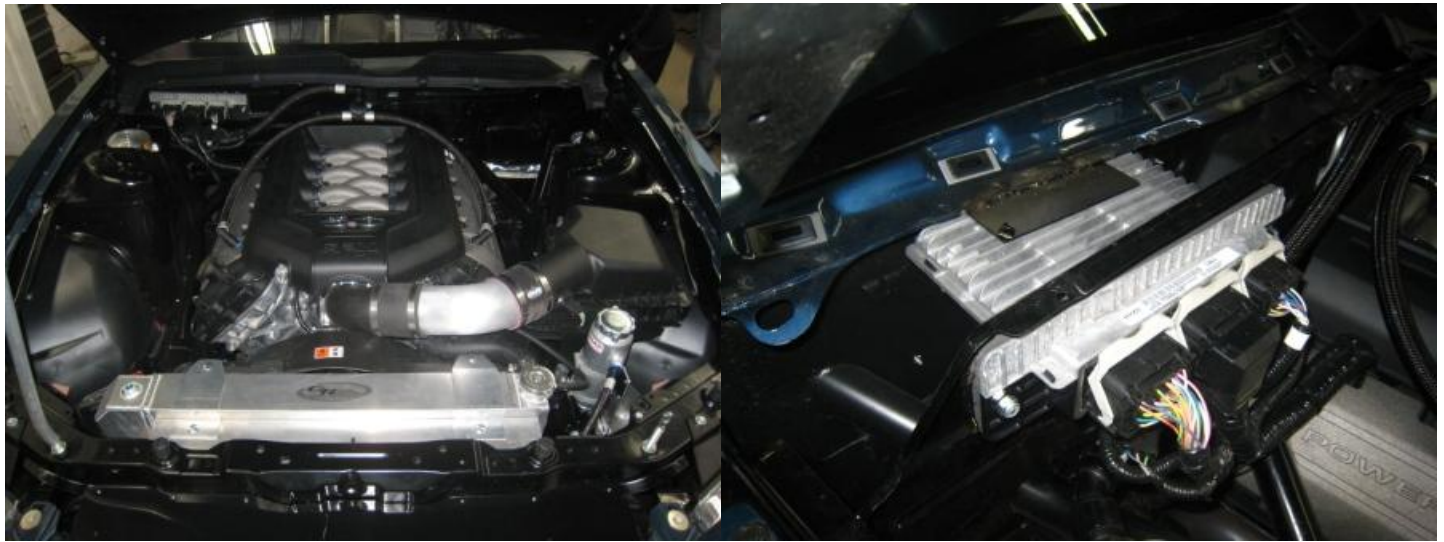

PCM Calibration Application Notes:

- The calibration provided in this PCM will NOT work with the 'Returnless' fuel system as used on factory Mustang vehicles. Use of a return style fuel system is required. Refer to section 9 of this manual for more information on fuel system requirements for this PCM.
- The Air Filter Assembly with Integral Mass Air Flow Sensor included with this kit must be used to achieve acceptable engine performance. Refer to section 3.5 for more information about Air Inlet System requirements.
- **Premium Fuel Only (91 Octane or higher).**



Factory Ford shop manuals are available from Helm Publications, 1-800-782-4356



FORD PERFORMANCE

M-6017-A504VB 2011-2014 Coyote 5.0L Crate Engine Controls Pack INSTRUCTION SHEET

NO PART OF THIS DOCUMENT MAY BE REPRODUCED WITHOUT PRIOR AGREEMENT AND WRITTEN PERMISSION OF FORD PERFORMANCE PARTS

NOTE: Due to the fuel system requirement described above, installation of this PCM in ANY Production Mustang vehicle will result in a no-start condition!

3.4 Universal Exhaust Gas Oxygen Sensor (UEGO) 8F9A-9Y460-EA

Two UEGO sensors provide wide range feedback to the PCM for closed loop air fuel ratio control.

* Apply a light coat of anti-seize lubricant to the threads of the UEGOs before installing. This lubricant will damage the sensor element so make sure no lubricant comes in contact with the sensor element. Tighten to 48 Nm (35 lb-ft).

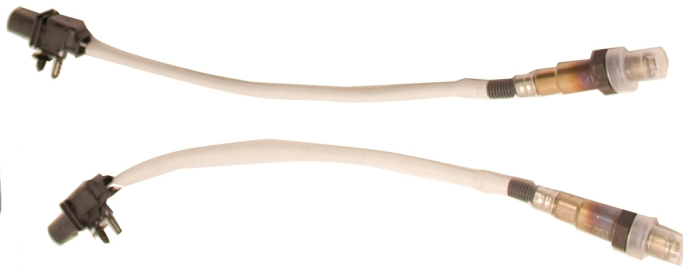

The engine harness and controls package M-6017-A504V is designed to operate with the UEGO sensors in the 2011-2012 Mustang GT stock locations. Moving the UEGO sensors to alternate locations can result in the need to recalibrate the PCM.

Here are some tips if sensors have to be relocated.

The best option is to locate the sensor so it is sampling from all 4 cylinders and at a distance that does not require modification of the UEGO harness.

NOTE: Modification of the UEGO harness can affect function of UEGO sensor.

If your header design will not allow you to sample all 4 cylinders without UEGO harness modifications, a better alternative is locating the UEGO sensor to sample from a single cylinder.

The cylinders that have (on average) the closest A/F ratio to the bank average are cylinder #4 (on bank 1) and cylinder #7 (on bank 2). If that's not possible due to packaging constraints, the next best choices are cylinder #3 (on bank 1) and cylinder #8 (on bank 2). Calibration required!

Factory Ford shop manuals are available from Helm Publications, 1-800-782-4356



FORD PERFORMANCE

M-6017-A504VB 2011-2014 Coyote 5.0L Crate Engine Controls Pack INSTRUCTION SHEET

NO PART OF THIS DOCUMENT MAY BE REPRODUCED WITHOUT PRIOR AGREEMENT AND WRITTEN PERMISSION OF FORD PERFORMANCE PARTS

Firing Order:

1 - 5 - 4 - 8 - 6 - 3 - 7 - 2

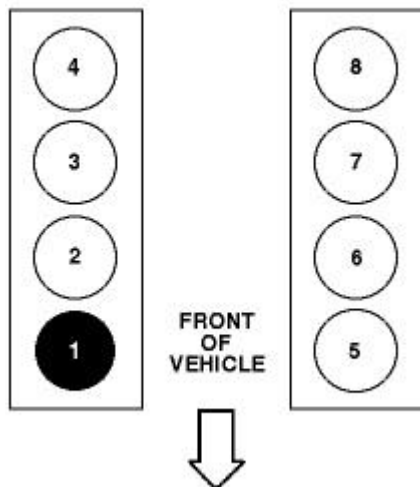

3.5 Air Cleaner Assembly with Integral Mass Air Flow Sensor BR33-9600-BC



IMPORTANT NOTE: The calibration of the PCM you have received requires use of this air box/MAF sensor system exactly as received. Any changes to the air inlet system will result in changes to how the air entering the engine is measured and will require modification to the PCM's calibration.

Ford Performance Part recognizes that it may not be practical to package this Air Box/MAF sensor system in some vehicle applications. The recommendations listed below are intended to serve as guidelines for designing an air inlet system that will provide good control system performance once the control system calibration has been modified to work with the new Air Inlet System:

Factory Ford shop manuals are available from Helm Publications, 1-800-782-4356



FORD PERFORMANCE

M-6017-A504VB 2011-2014 Coyote 5.0L Crate Engine Controls Pack INSTRUCTION SHEET

NO PART OF THIS DOCUMENT MAY BE REPRODUCED WITHOUT PRIOR AGREEMENT AND WRITTEN PERMISSION OF
FORD PERFORMANCE PARTS

- 1) Flow Profile: the MAF sensor should be located on a straight section of zip tube where the flow profile is generally uniform. If the sensor cannot be located on a straight section put the sensor on the outside radius of the zip tube so the sensor is located in the higher flow velocity area.
- 2) Flow Area: Keep the cross sectional area of the MAF sensor tube as close as possible to the cross sectional area of the original induction system.
- 3) Flow quality: minimize flow direction changes and maintain smooth tubing to minimize air flow disturbances and turbulence.
- 4) Flow pulsation: install sensor at least 6 to 8 inches upstream of the throttle body.
- 5) Transient performance: installing the sensor too far upstream of the throttle body (>24 inches) will result in transient lean/rich spikes due to the additional amount of time required for the measured air flow to travel from the MAF sensor to the intake manifold.
- 6) MAF sensor contamination: A) install sensor in upper half of cross sectional area to minimize possibility of condensation coming in contact with the MAF sensor element. In other words, if a clock is superimposed on a cross section of the zip tube, the sensor should be installed somewhere equal to or above the 9:00 and 3:00 positions. Most OEM applications have the sensor located at the 9:00 or 3:00 location. B) Sensor must be installed downstream of air filter and upstream of blow-by inlet. Ideally, sensor should be located 3 diameters upstream of the blow-by inlet.

4.0 TOOLS REQUIRED

In addition to a common assortment of sockets, wrenches and screwdrivers, you will also need the following:

- Wire Strippers
- Digital Volt/Ohm Meter
- Solder Gun / Solder
- Electrical Tape / Shrink Tubing
- Hand Drill
- Hole Saw
- Utility Knife

5.0 PRE-INSTALLATION

The following is a list of key factors to consider before any installation takes place:

- PCM mounting location is limited by the lengths of the 2 corresponding leads into which the PCM is connected. These leads are an integral part of the CRATE ENGINE HARNESS (not included with Controls Pack)
- Ford Performance Power Distribution Box must be mounted within 60" of the vehicle battery as dictated by the Battery+/ Ground Lead Lengths of the controls pack wiring harness
- Lay out the harness and components first in order to ensure that the wiring leads will reach everywhere you intend them to. This is a good reality check before you drill any holes or mount any components!

Factory Ford shop manuals are available from Helm Publications, 1-800-782-4356



FORD PERFORMANCE

M-6017-A504VB 2011-2014 Coyote 5.0L Crate Engine Controls Pack INSTRUCTION SHEET

NO PART OF THIS DOCUMENT MAY BE REPRODUCED WITHOUT PRIOR AGREEMENT AND WRITTEN PERMISSION OF FORD PERFORMANCE PARTS

6.0 HARNESS WIRE COLORS AND CONNECTOR LOCATIONS

Item	Connector #	Description	Item	Connector #	Description
A	-	FPPDB	J	C1571	UEGO#1 RH
B	-	Battery ground BL	K	C1572	UEGO#2 LH
C	C251	Data Link Connector	L	-	Starter Solenoid Feed
D	-	Speed Dial Blunt Leads	M	C175T	50-way transmission pocket
E	C257	CPP-BT	N	C175B	70-way cowl pocket
F	C2040	APPS	O	C146	Auxiliary Inline to Engine harness
G	C160A	I/P Pigtail Connector	P	-	Cooling Fan Feed/Ground
H	-	Vsout Blunt Lead	Q	C102A	Alternator
I	C160B	I/P Pigtail	R	C128	MAF

NOTE: Cooling fan is switched on at 195F, turns off at 190F. This is based on inferred engine coolant temperature. Engine coolant temperature is inferred from the cylinder head temperature. Inferred coolant temperature may not be the same as actual coolant temperature.

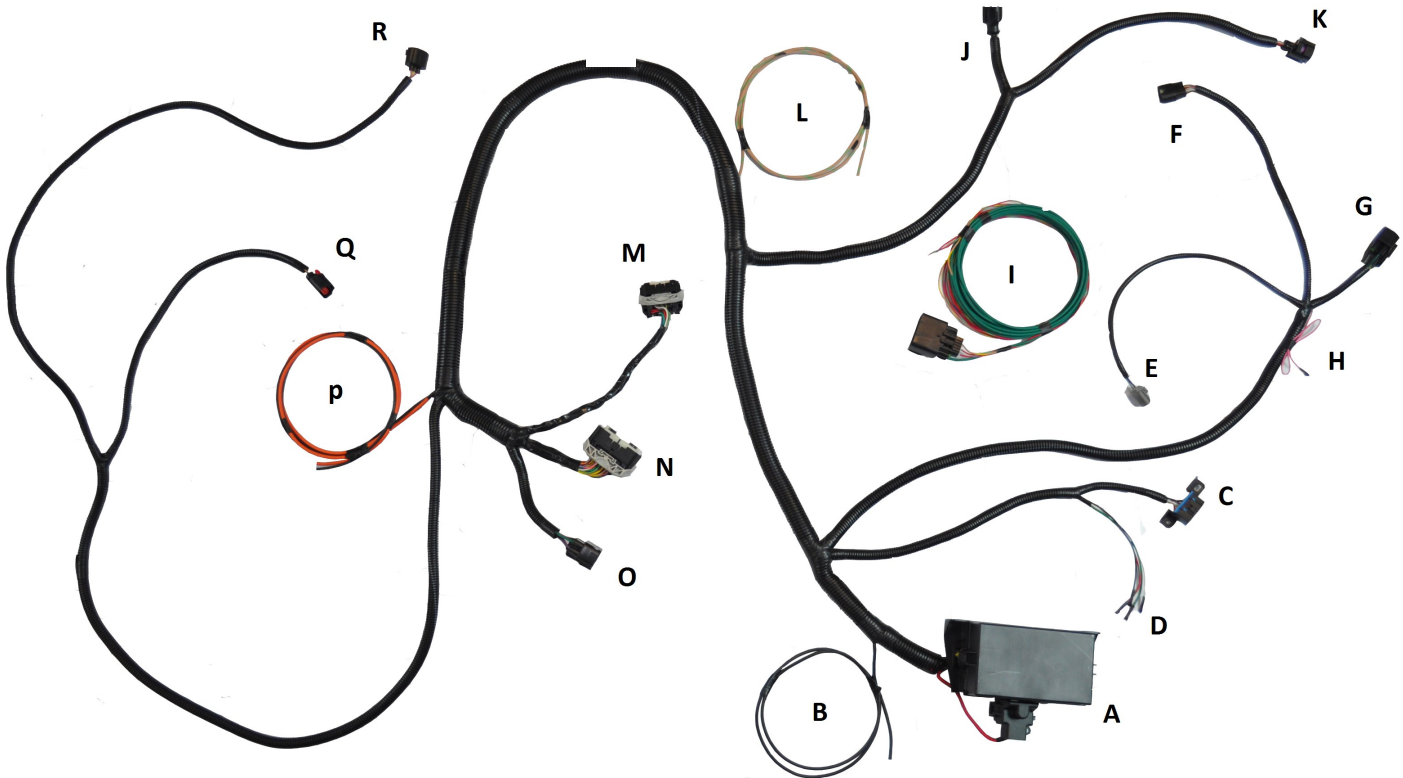

Factory Ford shop manuals are available from Helm Publications, 1-800-782-4356



FORD PERFORMANCE

M-6017-A504VB

2011-2014 Coyote 5.0L Crate Engine Controls Pack INSTRUCTION SHEET

NO PART OF THIS DOCUMENT MAY BE REPRODUCED WITHOUT PRIOR AGREEMENT AND WRITTEN PERMISSION OF
FORD PERFORMANCE PARTS

7.0 HARNESS INSTALLATION

NOTE: To avoid electrical shock and/or damage to sensitive electrical control system components, before beginning any work, remove the vehicle's Negative Battery Terminal and place a rag or towel between it and the Battery Negative Post. The Negative Battery Terminal is not to be reinstalled until the last step of installation.

1. Identify proper mounting location for the PCM, Power Distribution Box (Item A). Locate the 70-way PCM connector (C175E) on the engine harness.
2. If a stock PCM is present (crate engines do NOT include a stock PCM, only the controls pack PCM), unplug it and store it in a cool, dry place in case it is needed in the future.
3. Plug C175E (from the engine harness) and C175B (Item N from the controls pack harness) into the controls pack PCM; once plugged-in, use a zip-tie to tie the bundle of wires exiting each connector back together. In the steps that follow, we will be repeating this process of using zip-ties to piggy-back/tie the controls pack harness to the existing engine harness approximately every 200 mm or so along the engine harness.
4. Connect the in-line connector (C146) from the controls pack harness to the mating connector on the engine harness.
5. Connect Alternator Connector (C102A), Mass Air Flow (C128) to their respective locations being sure to avoid any pinch-points or exhaust hot-spots.
6. Connect Blunt-cut orange 10AWG cooling fan lead and Starter Lead Eyelet to their respective locations.
7. All connections previously mentioned are located under hood; all connections mentioned from this point on are located in the passenger compartment.
8. Identify proper mounting location for the Accelerator pedal, Clutch Bottom of Travel (purchased separately) and Ignition Switch (purchased separately).
9. Identify mounting location for DLC connector (Item C).
10. Connect the ground wire (Item B) to a reliable ground point on the chassis or engine block, away from dirt and water.
11. Route C160A to approximately the base of the steering wheel to be connected later.
12. Connect each of the connectors to their respective locations mentioned above (C2040, C257).
13. Locate the 16-way I/P Pigtail connector with blunt leads (Item I) and continue to Section 6.

* Removal Procedures for Unused Connectors:

If 100% sure connector is not currently needed and will not be needed in the future, cut routing leading-up to unused connector and individually heat shrink each wire herein. To ensure that the wires are completely isolated from one another and the outside environment, you may also want to wrap the heat-shrunked wire in electrical tape to provide an additional layer of protection from moisture and dirt.

Important Note on the Starting System

This kit includes connections and installation instructions for PCM controlled engine starting; however, it is **not required** that the customer utilize this option. Customers may choose to use their existing non-PCM controlled starting system if desired. If non-PCM controlled starting is used, unused blunt leads should be cut to ~2" length and sealed using heat shrink.

Factory Ford shop manuals are available from Helm Publications, 1-800-782-4356



FORD PERFORMANCE

M-6017-A504VB 2011-2014 Coyote 5.0L Crate Engine Controls Pack INSTRUCTION SHEET

NO PART OF THIS DOCUMENT MAY BE REPRODUCED WITHOUT PRIOR AGREEMENT AND WRITTEN PERMISSION OF
FORD PERFORMANCE PARTS

8.0 I/P PIGTAIL WIRING CONNECTIONS

- 8.1 Locate each of the Blunt Leads from connector C160B. This is where you will need to make all of the soldered connections for the harness.
- 8.2 Connect the blunt leads as follows:
- A. **Blunt Lead 1(pin1) – Fuel Pump (Dark Green):** Connect to Fuel Pump positive. Separate ground for fuel pump must be provided. The fuel pump will be running any time key is on.
 - B. **Blunt Lead 2(pin5) – Ignition Switch Position (Red/Light Green Wire):** Connect this wire to a **SINGLE SOURCE** on the ignition switch that provides 12 Volts when the key is in the 'Start' (cranking) and 'Run' position. It is imperative that this circuit be reliable, the PCM will interpret an intermittent voltage on this signal as a request to shut down the engine! (Hint, if your engine shuts down after a hard launch check here first).
 - C. **Blunt Lead 3(pin3)– Starter Motor Request (Red/Light Blue):** Connect to start node of ignition switch so that 12 volts is provided when engine starting is requested.*
 - D. **Blunt Lead 5(pin7) - CTO (Tan/Yellow):** This wire is the tachometer lead. This is not a mandatory connection.*

9.0 Ford Performance Power Distribution Box Installation (recommended)

- 9.1. Before you start, you should have your two battery jumper cables, in-line fuse and fuse holder(optional) at hand (purchased separately, 4 AWG recommended), one from Battery to fuse holder, the other one from fuse holder to FPPDB.
- 9.2. Carefully remove the nut and washers on both terminals of the in-line fuse holder and set aside.
- 9.3. Use one of your battery cables and place the eyelet onto one of the two in-line fuse holder terminals, then one of the washers, and then tighten down with one of the two nuts.
- 9.4. Locate the power terminal of the side of FPPDB, notice there is a battery positive blunt lead eyelet already attached to it. Attach the other eyelet to this power terminal by tightening the nut down on top of the eyelet. The order of installation on the power terminal should be a washer, the battery cable eyelet, then the blunt lead eyelet, another washer, and then the nut. Avoid sharp points and using zip-ties to secure the cable (approximately every 200 mm) along the way. **DO NOT CONNECT ANYTHING TO THE BATTERY YET.**
- 9.5. Place the In-line fuse onto the fuse holder terminals.
- 9.6. On the opposite in-line fuse holder terminal, place one eyelet of your second battery cable, then the other remaining washer, and then tighten down with the remaining nut.
- 9.7. Close the cover of the in-line fuse holder.
- 9.8. Being careful not to inadvertently complete the circuit, connect the opposite end of the battery cable to the positive terminal of the vehicle battery.

Note: This lead **MUST** be hot at all times (HAAT). If this lead is connected through a switch, the Keep Alive Memory (KAM) of the PCM will be cleared whenever the switch is opened. This will result in loss of diagnostic trouble codes, adaptive fuel parameters, and other information stored in KAM by the PCM.

- 9.9. Install and tighten the Negative Battery Terminal (not included in kit) onto the Vehicle Battery. Attach the ground blunt lead to the Negative Battery Terminal (you will need to provide the eyelet). Verify that you have a good reliable (dry and

Factory Ford shop manuals are available from Helm Publications, 1-800-782-4356



FORD PERFORMANCE

M-6017-A504VB 2011-2014 Coyote 5.0L Crate Engine Controls Pack INSTRUCTION SHEET

NO PART OF THIS DOCUMENT MAY BE REPRODUCED WITHOUT PRIOR AGREEMENT AND WRITTEN PERMISSION OF FORD PERFORMANCE PARTS

clean) ground path from the battery negative post to the chassis ground. In general, the resistance from the battery ground to this chassis location should be less than 0.1 ohm.

10.0 Fuel System

The PCM is calibrated for a return style fuel system as shown below.

Notes:

- Set regulator to maintain 55 psi delta fuel pressure across injector (55 psi at fuel rail with engine off):
- Use only AN type fuel fitting to interface with OEM fuel rail.
- Fuel pressure regulator must have reference to manifold vacuum.

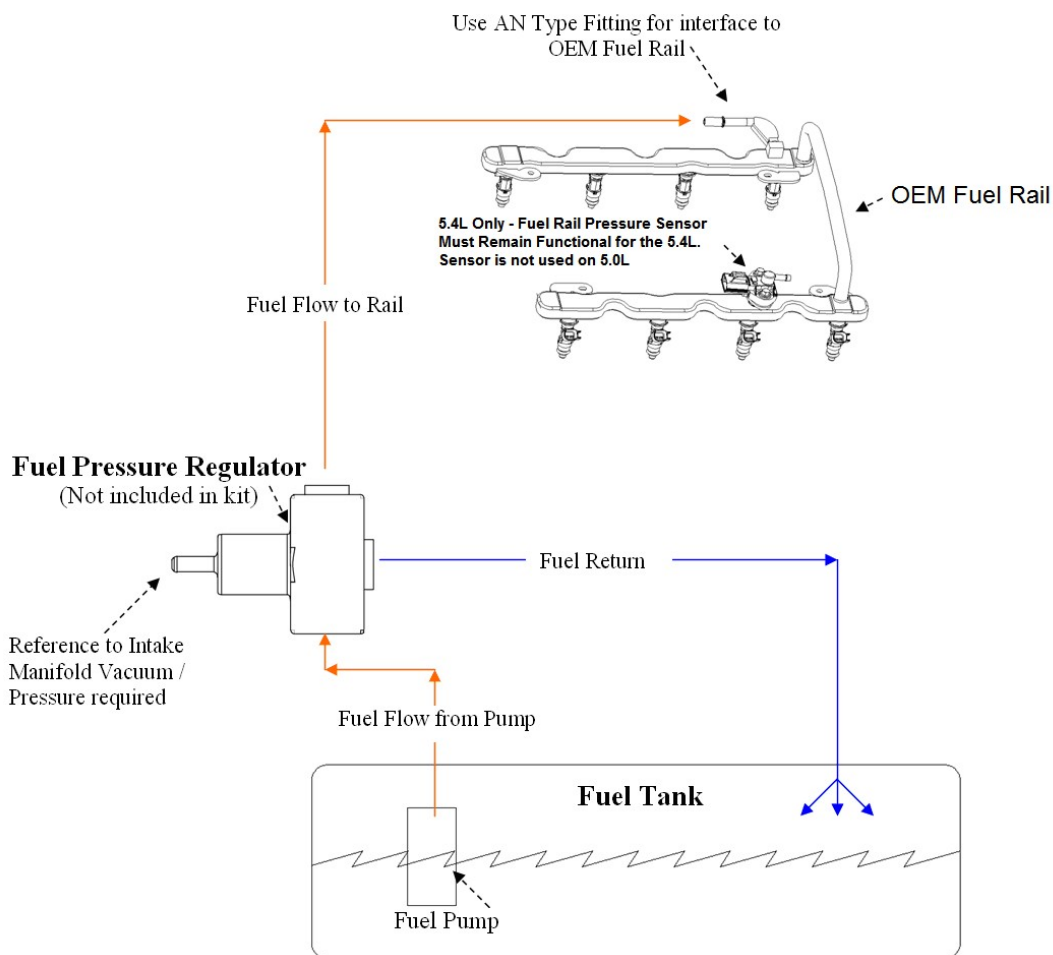

Factory Ford shop manuals are available from Helm Publications, 1-800-782-4356



FORD PERFORMANCE

M-6017-A504VB 2011-2014 Coyote 5.0L Crate Engine Controls Pack INSTRUCTION SHEET

NO PART OF THIS DOCUMENT MAY BE REPRODUCED WITHOUT PRIOR AGREEMENT AND WRITTEN PERMISSION OF
FORD PERFORMANCE PARTS

Fuel pump requirements: 155L/Hr minimum at 55psi

Fuel pump location

A common and often overlooked problem is the location of the fuel pump or pumps. Optimally, the fuel pump should be mounted IN THE TANK to reduce the possibility of pump cavitation. Cavitation is essentially localized boiling caused by a reduction in pressure, generally occurring on the inlet side of a pump. This localized boiling results in fuel vapor bubbles which will reduce the volume of fuel the pump is capable of delivering to the engine. Any reduction in pressure or increase in temperature at the inlet side of the pump increases the chances that cavitation will occur. For this reason, it is always best to either have the pump inside the tank immersed in fuel or (in the case of an external pump) gravity fed, which will increase the pressure on the inlet side of the pump. If the fuel pump has to "pull" the fuel, this will result in a reduction in pressure at the fuel pump inlet potentially allowing cavitation and, thus, vapor bubbles to develop. These vapor bubbles are then drawn into the fuel pump and exit the high-pressure side of the fuel pump as compressed vapor.

They travel the entire length of the fuel system and are expelled through the fuel injector. This can cause issues ranging from stumbles and hesitations to engine damage due to insufficient fuel delivery and lean A/F ratios. Sometimes this problem can characterize itself by only appearing when the weather gets warmer, which can confound the diagnosis of the issue. In certain cases, it may seem to only develop when driving on certain surfaces, because pavement reflects more heat than an off-road 4x4 trail. Remember, more heat and lower pressure on the inlet side of the pump means a greater chance of cavitation, which is to be avoided whenever possible.

If you are using an external mounted fuel pump, you should run a very coarse (typically around 100 micron) filter on the inlet side of the fuel pump, and a finer (typically around 10 micron) filter on the outlet side of the pump. A paper filter is NOT recommended on the inlet of the fuel pump because it can cause a restriction in fuel flow which, as mentioned previously, can lead to cavitation.

Warning: It is highly recommended that an inertia switch is incorporated into the fuel pump wiring to turn off the fuel pump in event of an accident.

11.0 INITIAL START UP

The following information assumes completion of each of the previous steps of this installation manual

11.1 Check all fluid levels, electrical and fluid connections.

11.2 Pressurize the fuel system by turning the key on. Inspect the entire fuel system (from tank to engine) for leaks.
If any leaks are found, do not proceed further until these have been corrected.

11.3 Start Engine. Check for leaks and/or noises that may indicate a problem.

CAUTION: Be certain to run the vehicle in a well ventilated area.

Factory Ford shop manuals are available from Helm Publications, 1-800-782-4356



FORD PERFORMANCE

M-6017-A504VB 2011-2014 Coyote 5.0L Crate Engine Controls Pack INSTRUCTION SHEET

NO PART OF THIS DOCUMENT MAY BE REPRODUCED WITHOUT PRIOR AGREEMENT AND WRITTEN PERMISSION OF FORD PERFORMANCE PARTS

12.0 Fuses & Relays

The following diagram outlines the array of fuses and relays included in the controls pack wiring harness, and the function of each.

NOTE: Do NOT replace any of the fuses with a higher value than those specified below.

Component ID	Type	Value	Name
JC1	J-Case Fuse	50A	PCM Relay Feed
JC2	J-Case Fuse	50A	Cooling Fan Relay Feed
JC3	J-Case Fuse	30A	Starter Relay Feed
JC4	J-Case Fuse	40A	Fuel Pump Relay Feed
JC5	J-Case Fuse	40A	Ignition Relay Feed
F1	Minifuse	20A	VPWR1
F2	Minifuse	20A	VPWR2
F3	Minifuse	15A	VPWR3
F4	Minifuse	15A	VPWR4
F5	Minifuse	10A	Ignition Switched A
F8	Minifuse	10A	VPWR7
F9	Minifuse	15A	VPWR6
F10	Minifuse	10A	HAATA
F11	Minifuse	10A	KAPWR (12 HAA T)
R1	Power Mini Relay	70A	PCM Relay
R2	Power Mini Relay	70A	Cooling Fan Relay
R3	High Current Micro Relay	40A	Starter Relay
R4	High Current Micro Relay	40A	Fuel Pump Relay
R6	High Current Micro Relay	40A	Ignition Relay

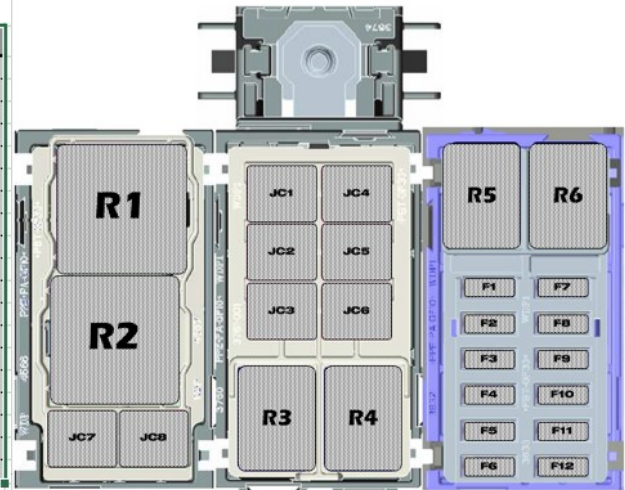

13.0 Troubleshooting tips:

The following troubleshooting tips are intended for you to run a few quick tests to roughly determine what the issues are before calling or find a solution yourself:

- Always double check all your grounds. The wirings included in this kit are extremely sensitive to ground issues. Secure all the connections from chassis grounds to battery negative. Do a continuity test with your multimeter between all your ground terminals and battery ground.
- Check for all you reference voltage 5V, make sure they are not short to elsewhere. Use a multimeter to measure the voltage. The reference voltage are sent out from PCM, if wirings are all good and still you have a different voltage level, PCM might not be properly calibrated.
- If you don't have any power at all, check for your ignition switch, ignition relay R6 and PCM relay R1 wirings. You should have 12V at both relay outputs once ignition on, which is fused via F5 and F1 separately. Again use a meter to measure the voltage at F5 and F1, 12V expected, there are tiny holes on all mini fuses for your probe to thrust in.
- If ignition circuitry works but no cranking, check for your starter switch and starter relay R3 wirings. You should have 12V at the relay output WHEN you push the start button. Use a meter to measure the voltage at the Starter solenoid leads from harness(disconnect from starter), 12V expected WHEN you push the start button.
- If your engine will only crank but not fire up, fuel system malfunction can be the cause in most cases. First make sure that you have 12V at fuel pump + and all injectors when key on. Measure the pressure at your fuel rail it should start building up once you hit starter button.

Factory Ford shop manuals are available from Helm Publications, 1-800-782-4356



FORD PERFORMANCE

M-6017-A504VB 2011-2014 Coyote 5.0L Crate Engine Controls Pack INSTRUCTION SHEET

NO PART OF THIS DOCUMENT MAY BE REPRODUCED WITHOUT PRIOR AGREEMENT AND WRITTEN PERMISSION OF FORD PERFORMANCE PARTS

14.0 Connector Faces (C for Cowl Pocket, T for Transmission pocket)

Clutch Pedal Bottom Travel Switch

(Normally Open)
(Key A)

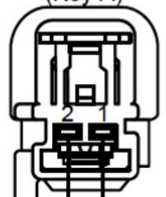

CPP-BT T-19
PWRGND

APPS Accelerator Pedal Position Sensor

(Key A)

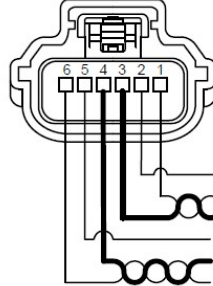

* APP 1 C-28
* ETCREF (A) C-45
* ETCRTN (A) C-44
* APP 2 C-29
* ETCRTN (B) C-60
* ETCREF (B) C-61

Diagnostic / Data Link Connector

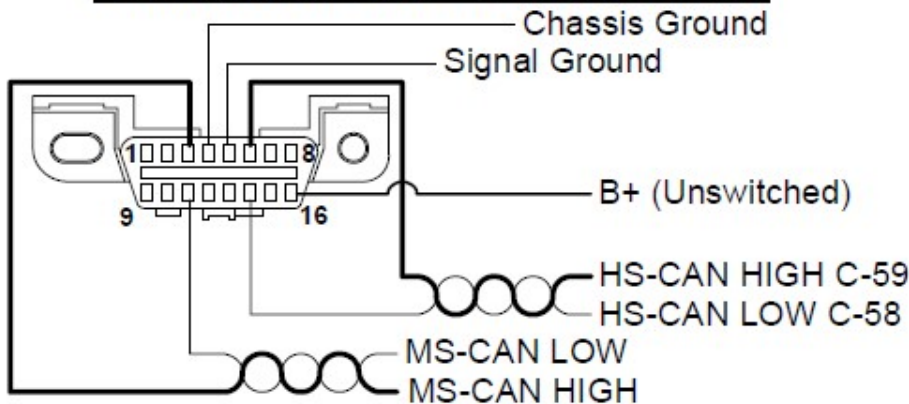

MAF/IAT Mass Air Flow Intake Ambient Temperature Sensor

(Key B)

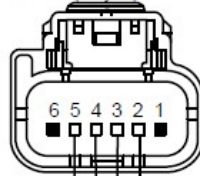

IAT C-47
VPWR #5
MAFRTN C-2
MAF (Freq.) C-40

ALTERNATOR

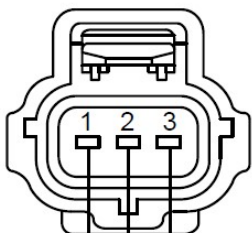

Battery Sense (VBAT Unswitched)
Regulator Control (GENRC) C-53
Load Indicator (GENLI) C-14

Factory Ford shop manuals are available from Helm Publications, 1-800-782-4356



FORD PERFORMANCE

M-6017-A504VB 2011-2014 Coyote 5.0L Crate Engine Controls Pack INSTRUCTION SHEET

NO PART OF THIS DOCUMENT MAY BE REPRODUCED WITHOUT PRIOR AGREEMENT AND WRITTEN PERMISSION OF FORD PERFORMANCE PARTS

UEGO Upstream

Universal Exhaust Gas Oxygen Sensor

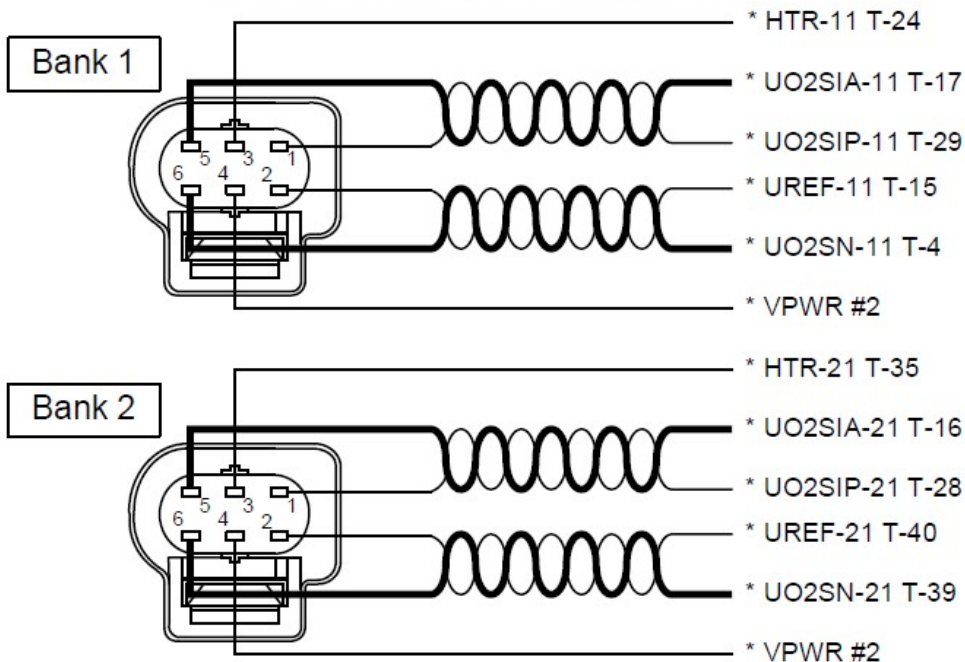

70 Way "Key D"

70 Way "Key E"

50 Way "Key C"

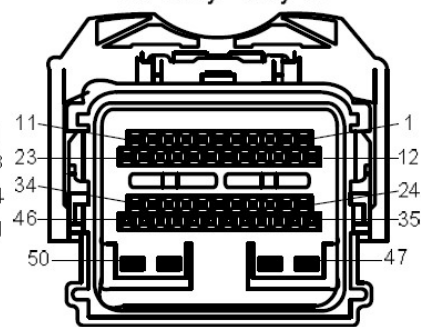
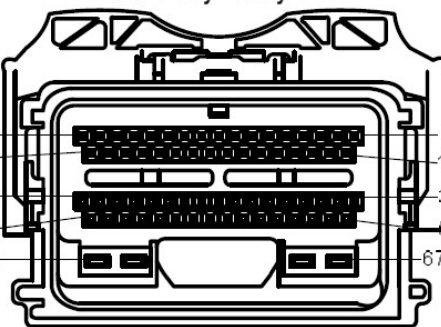
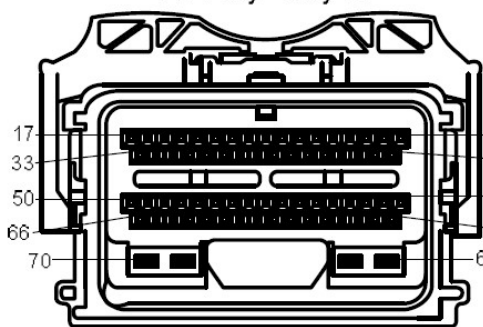

Cowl

Engine

Transmission

Factory Ford shop manuals are available from Helm Publications, 1-800-782-4356