



# HP FUEL PUMPS

## P/N 12-125 & 12-150

### Installation Instructions 199R10367

**WARNING!** THESE INSTRUCTIONS MUST BE READ AND FULLY UNDERSTOOD BEFORE BEGINNING INSTALLATION. FAILURE TO FOLLOW THESE INSTRUCTIONS MAY RESULT IN POOR PERFORMANCE, VEHICLE DAMAGE, PERSONAL INJURY, OR DEATH. IF THESE INSTRUCTIONS ARE NOT FULLY UNDERSTOOD, INSTALLATION SHOULD NOT BE ATTEMPTED. PLEASE CONSULT HOLLEY TECH SERVICE OR A QUALIFIED MECHANIC.

#### APPLICATIONS:

P/N	DESCRIPTION	FLOWS	PRESSURE REGULATOR	ALCOHOL/METHANOL COMPATIBLE	PRESET PRESSURE	SAFETY SWITCH SHUT-OFF
12-125	Billet Aluminum Pump. One 3/8" NPT Inlet, One 3/8" NPT Outlet	125 GPH Free Flow	Not Needed	Yes	7 PSI max	Recommended (P/N 12-810)
12-150	Billet Aluminum Pump. One 3/8" NPT Inlet, One 3/8" NPT Outlet	150 GPH Free Flow	12-803 included	Yes	17 PSI max	Recommended (P/N 12-810)

#### INTRODUCTION:

Congratulations on your purchase of the **Holley HP fuel pump**. This instruction sheet contains all the information needed to install this fuel pump. Please read all the **WARNINGS** and **NOTES**. They contain valuable information that can save you time and money. Holley Performance Products cannot and will not be responsible for any alleged or actual engine or other damage, or other conditions resulting from misapplication of the **HP** fuel pumps and fuel pressure regulators described herein. However, it is our intent to provide the best possible products for our customer; products that perform properly and satisfy your expectations. Should you need information or parts assistance, please contact our Technical Service Dept. at 1-270-781-9741, M-F, 8 a.m. to 6 p.m. & Sat. 9 a.m. to 3 p.m. CST. Please have the part number ready when you call.

**NOTE:** A screen type pre-filter (80-100 micron), top quality fuel filter at 70 micron or less, fuel hose and clamps, 12 gauge wire, fuel fittings, assorted terminals, a relay, and an optional safety shut-off switch is required to complete the installation of the **HP** fuel pump. These parts are not included with the **HP** fuel pump.

**NOTE:** The 12-150 HP fuel pump requires the use of a fuel pressure regulator. Holley P/N 12-803 is included for this reason.

**NOTE:** For optimum performance and precise fuel control, Holley **ALWAYS RECOMMENDS** using a Fuel Pressure Regulator.

#### SPECIAL CONSIDERATIONS FOR PUMPS SUBJECTED TO HIGH TEMPERATURES:

In applications where the fuel pump is subjected to high temperatures due to climate, towing, close proximity of exhaust components, high under-car temperatures, etc., Holley highly recommends the use of a bypass style regulator (such as Holley PN 12-803BP) to eliminate potential vapor lock issues that may occur due to the sensitivity of new fuels. If you are experiencing fluctuations in pressure readings or no-flow conditions when temperatures rise, you will need to install a bypass regulator.

#### PUMP MOUNTING AND INSTALLATION:

The best location for mounting any electric fuel pump is the rear of the vehicle, near the fuel tank and in a position lower than fuel level that will allow the fuel to be gravity fed to the pump. The pump should be mounted on a solid member, such as the chassis, in a vertical position with the pump motor on top. Avoid exposure of the pump and fuel lines to moving parts and to any hot areas, such as the exhaust manifold. The pump should not be mounted in an enclosed area, such as the vehicle's trunk. Follow the steps below for mounting the pump.

**WARNING!** THE PUMP MUST BE PLACED WHERE INTERFERENCE BETWEEN THE VEHICLE'S BODY AND ITS CHASSIS MOVEMENT IS AVOIDED. THE PUMP AND ITS CONNECTING HOSES MUST NOT BE SUBJECTED TO LOW GROUND CLEARANCE, WHERE ANY FLYING ROCKS OR ROAD DEBRIS CAN CAUSE DAMAGE. FAILURE TO AVOID THESE HAZARDS WILL LEAD TO PUMP DAMAGE, WHICH COULD RESULT IN FIRE AND/OR PROPERTY DAMAGE, SERIOUS INJURY, AND/OR DEATH.

1. Select a mounting site as close as possible to the fuel supply and away from possible sources of heat as detailed previously.
2. Use the mounting bracket attached to the pump as a template and drill two clearance holes for 5/16" bolts.
3. Mount the pump in the vertical position (motor on top) using two 5/16 bolts.

**NOTE:** To ensure pump life and flow efficiency, a quality screen type pre-filter, such as Earl's "-8" Pre-Filter (P/N 230208ERL) must be installed between the tank and the pump inlet. The filter should be supported in such a manner that it does not hang from the fuel lines.

4. Connect the fuel line from the tank to the pre-filter and then **to the inlet port of the pump**. Connect the carburetor delivery line to the outlet port of the pump to the fine micron fuel filter and to the regulator (for the 12-150) located near the carburetor inlet. See **Figures 1, 2a, and 2b**. The fuel pump inlet and outlet ports take a 3/8" NPT fitting, therefore a 3/8" or larger fuel line is recommended.
5. Install the fuel fittings. Teflon paste can be used on the fittings and torqued to 15 ft./lbs. See warning below.

**WARNING! DO NOT USE TEFLON TAPE ON PUMP FITTINGS. THIS TAPE CAN BREAK DOWN WHEN IT COMES IN CONTACT WITH FUEL. THE TEFLON TAPE MAY PLUG THE FUEL PUMP, CAUSING DAMAGE TO THE PUMP AND THE FUEL SYSTEM.**

**NOTE:** Avoid unnecessary restrictions, such as sharp bends and undersized fuel fittings and hoses. Avoid routing fuel lines in areas that would cause chafing. All fuel line connections must be leak proof.

**WARNING! IF SPLICING INTO EXISTING FUEL LINES, USE EXTREME CARE TO AVOID CONTAMINATING THE LINE WITH RUBBER OR METAL SHAVINGS, AS THIS WILL DAMAGE THE PUMP. IF THE FUEL LINE HAS BEEN CUT, IT IS ESSENTIAL THAT IT BE CLEANED TO ENSURE THAT NO METAL OR RUBBER PARTICLES ENTER THE FUEL SYSTEM. THIS IS PERFORMED BY BLOWING THE LINE CLEAN WITH COMPRESSED AIR. HOLLEY DOES NOT RECOMMEND THE PROCEDURE WHERE THE COIL WIRE IS DISCONNECTED, THE ENGINE IS CRANKED, AND THE FUEL IS COLLECTED IN A CONTAINER. SPARKING CAN OCCUR DURING THIS PROCEDURE, WHICH MAY RESULT IN A FIRE AND/OR EXPLOSION.**

**WARNING! DO NOT OVER TIGHTEN THE FITTINGS ON THE FUEL PUMP. TORQUE 3/8" NPT FITTINGS ONLY TO 15 FT/LBS. OVER TIGHTENING OF THE FITTINGS CAN CAUSE THE PUMP BASE TO CRACK ALLOWING FUEL TO LEAK. A FUEL LEAK CAN CAUSE A FIRE AND/OR EXPLOSION RESULTING IN PROPERTY DAMAGE, SERIOUS INJURY, AND/OR DEATH.**

## USING A FUEL PRESSURE REGULATOR WITH A FUEL PUMP:

If the pump is a high-pressure model, a pressure regulator must be installed in the line between the pump and the carburetor.

**NOTE:** For optimum performance and precise fuel control, Holley **ALWAYS RECOMMENDS** using a Fuel Pressure Regulator.

1. Using the bracket supplied with the regulator, position the regulator as close to the carburetor as possible, taking care to minimize the exposure to heat sources. **DO NOT** mount the regulator on the exhaust manifold or any extremely hot surface.

**NOTE:** The fuel pressure regulator is included with the 12-150 (see **Figure 1**). Plug any unused ports.

2. Connect the fuel line from the "out" side of the pump to the "in" side on the regulator. All fuel line connections must be leakproof.
3. Connect the "out" side of the regulator to the fuel inlet on the carburetor(s). All fuel line connections must be leakproof.
4. The regulator comes from Holley with the regulator pressure preset at 6 psi. However, for individual requirements, it may be readjusted. The pressure is increased by loosening the regulator locknut and turning the adjustment screw clock-wise. Decrease pressure by turning the adjustment screw counter-clockwise. Pressure adjustments can only be made while the engine is running. Due to the high volume design of these regulators, pressure settings may not be maintained with a zero flow.

**WARNING! IF YOU TURN THE ADJUSTMENT SCREW ALL THE WAY IN, IT WILL RESULT IN EXCESSIVE FUEL PRESSURE AND CAUSE THE CARBURETOR TO FLOOD. A FLOODED CARB CAN CAUSE A FIRE AND/OR EXPLOSION, RESULTING IN PROPERTY DAMAGE, SERIOUS INJURY, AND/OR DEATH. ALWAYS USE A FUEL PRESSURE GAUGE, SUCH AS HOLLEY P/N 26-500 BETWEEN THE REGULATOR AND THE CARB(S) WHEN ADJUSTING THE FUEL PRESSURE REGULATOR.**

**NOTE:** Depending on your regulator, choose one of the following examples:

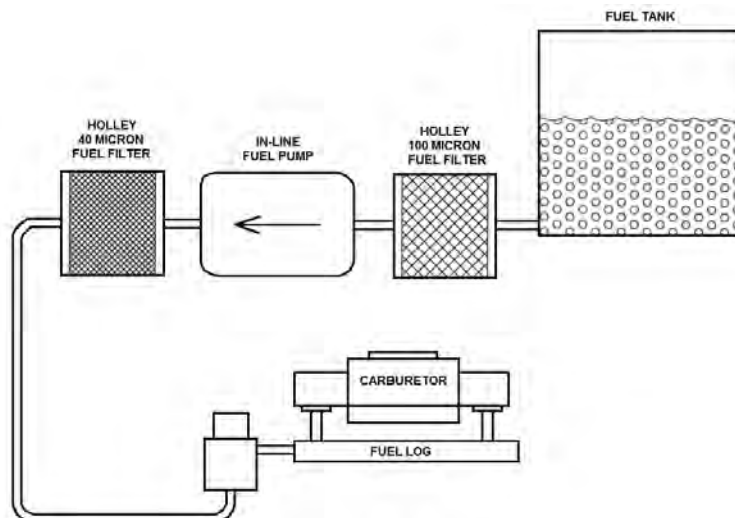

**Figure 1**

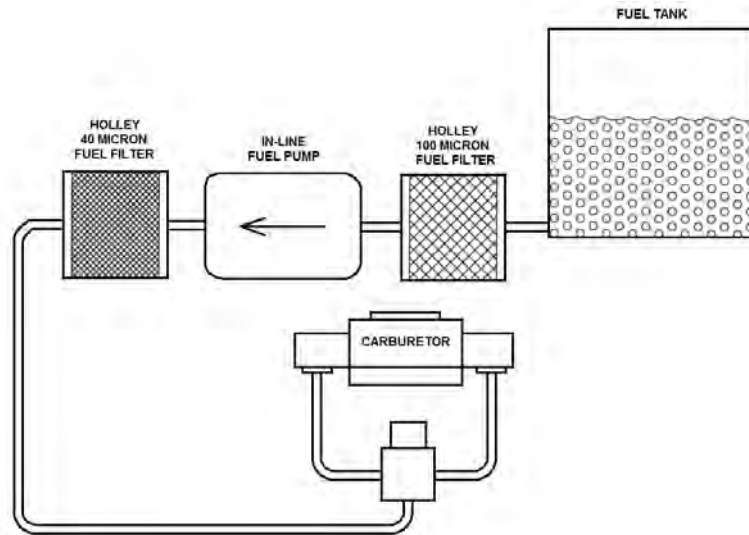

Figure 2a

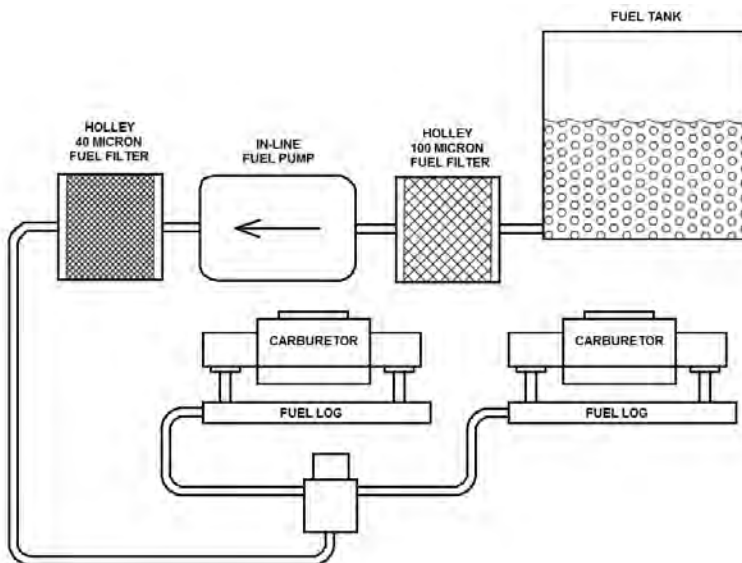

Figure 2b

**WIRING:**

There are 2 methods to wire the pump: (1) To wire the fuel pump with a relay. (2) To wire the fuel pump with an oil pressure safety switch.

**(1) WIRING THE FUEL PUMP WITH A RELAY:**

**NOTE:** You will need Holley Fuel pump relay kit P/N 12-753 or equivalent 4-wire relay.

1. Disconnect the cables from the battery.
2. Mount relay on firewall of engine compartment using a sheet metal screw.

**WARNING!** Before punching or drilling a hole in the firewall, make sure you know what is on the other side to avoid puncturing equipment such as heater cores, air-conditioning system equipment, hoses, or wiring.

3. Plug the fuel pump relay harness into the relay, until it locks into place.
4. If using a Holley relay, connect the black wire of the relay harness to a good clean ground using 12 gauge wire.
5. Connect the Green/Black wire to a switched 12V source.
6. Connect one of the red wires to the positive wire (red wire) of the fuel pump.

7. Attach the in-line fuse holder to the remaining red wire. After attaching the fuse holder, insert the 15A fuse and connect to the positive side of the battery using 12 gauge wire.
8. Reconnect the battery cables.

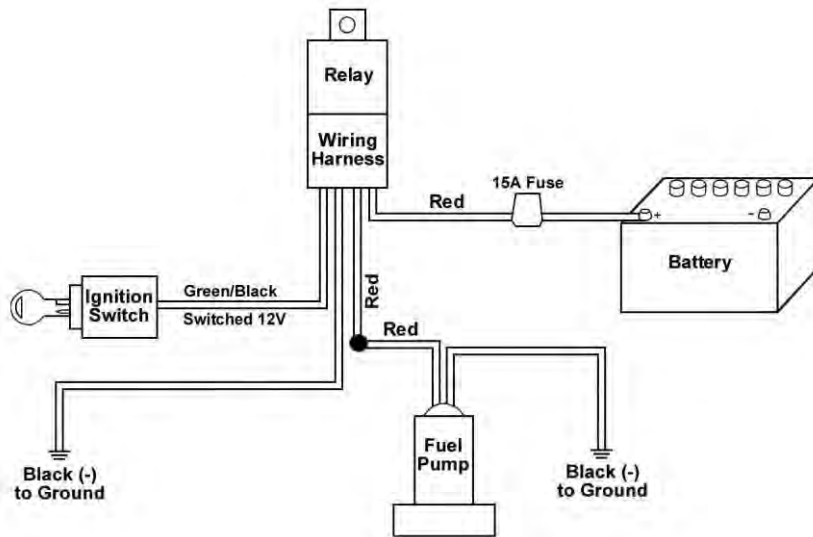

Figure 3

## (2) WIRING THE FUEL PUMP WITH AN OIL PRESSURE SAFETY SWITCH AND RELAY:

One method is to wire the pump to a switched 12-volt source (providing power only when the engine is running) located at the vehicle's electric panel. To ensure this condition, the installation of a Holley 12-810 oil pressure safety switch is recommended for installation into the wiring circuit. This will ensure that the pump will not continue to operate after the engine is shut off and/or when the key is left in the "ON" position. If the pressure switch is to be used, follow the installation instructions as outlined below (refer to Figure 3). Use 12 gauge wire for power (BAT+) and ground wires.

1. Disconnect the cables from the battery.
2. Remove the original equipment oil pressure switch and retain.
3. Screw a 1/8" pipe nipple into the hole from which the original pressure switch was removed. Use any suitable thread sealant on all fittings, taking care to avoid any excess that might contaminate the engine.
4. Screw a 1/8" pipe tee onto the nipple and position it in a manner to facilitate the installation of the original oil pressure switch and the new oil pressure safety switch in the remaining two holes.
5. Screw in the two switches and reconnect the lead to the original equipment oil pressure switch.

**NOTE:** The pump oil pressure switch will normally have three terminals marked: C (common), NC (normally closed), and NO (normally open).

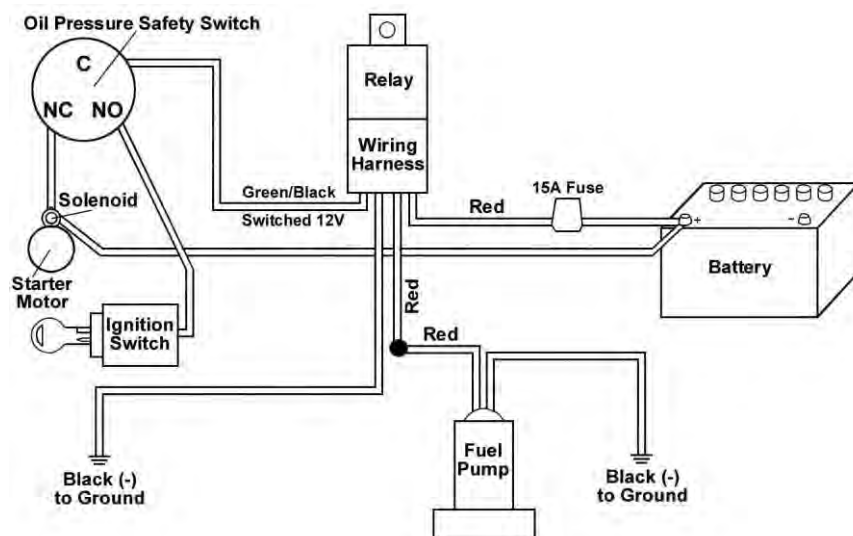

Figure 4

6. Mount relay on firewall of engine compartment using a sheet metal screw.

**WARNING!** Before punching or drilling a hole in the firewall, make sure you know what is on the other side to avoid puncturing equipment such as heater cores, air-conditioning system equipment, hoses, or wiring.

7. Plug the fuel pump relay harness into the relay, until it locks into place.
8. Connect the black wire of the relay harness to a good clean ground using 12 gauge wire.
9. Connect the Green/Black wire of the relay harness to the terminal marked "C" on the oil pressure safety switch.
10. Connect one of the red wires of the relay harness to the positive wire (red wire) of the fuel pump.
11. Connect the black wire of the fuel pump to a good clean chassis ground using a ring terminal
12. Attach the in-line fuse holder to the remaining red wire of the relay harness. After attaching the fuse holder, insert a 15A fuse and connect to the positive side of the battery using 12 gauge wire.
13. Connect the terminal marked "NO" of the safety switch to a switched 12V source..
14. Connect the terminal marked "NC" of the safety switch to the starter terminal that's hot (12V) during cranking only.
15. Reconnect the battery cables.

## MAINTENANCE AND CLEANING INSTRUCTIONS FOR HP PUMPS:

Due to the current poor quality gasoline that's available, it is recommended that periodically a can of dry gas (such as STP water remover) be used to absorb the water out of the fuel delivery system. The fuel pre-filter screen should be blown clean with compressed air every 6,000 miles and replaced every 12,000 miles to assure maximum protections. If your fuel pump fails to pump or fails to maintain adequate pressure, check the following:

1. Check the voltage at the pump to assure a 12 volt supply.
2. Check the fuel line (especially the fuel filter) for any obstruction. Use compressed air to blow the line free.
3. If this doesn't solve the problem, turn the pump on and listen for a hum from the top of the pump. If there is no hum, the pump electrical system should be checked by a competent repairman. If the pump hums, it probably only needs to be cleaned. See Figure 4.

## CLEANING THE PUMP:

The following is a step-by-step procedure for cleaning the Holley electric fuel pumps. Do all disassembling on a clean bench. Read all instructions thoroughly and completely before starting.

1. Remove the pump from the car.
2. Remove the inlet and outlet line fittings from the pump housing assembly.
3. Remove the filter screen from the inlet port and clean thoroughly with a spray-type carburetor cleaner.

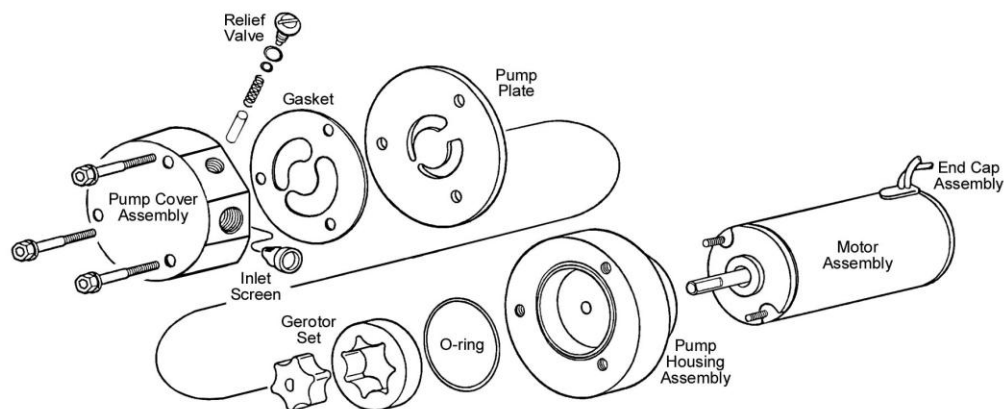

**Figure 5**

4. Turn the pump upside down, remove the three bolts, and carefully lift off the pump cover followed by the gasket, pump plate, and O-Ring.
5. Very carefully remove the gerotor assembly (both parts) from the pump housing.

**WARNING! KEEP THE GEROTOR TOGETHER AS A MATCHED SET. THIS ASSEMBLY MUST BE REASSEMBLED THE SAME WAY IT WAS DISASSEMBLED. THE TOP OF EACH PART MUST REMAIN TOWARD THE TOP OF THE PUMP.**

**WARNING! DO NOT IMMERSE THE ENTIRE UNIT IN ANY LIQUID. IMMERSION COULD DAMAGE THE ELECTRICAL CIRCUITRY, RESULTING IN A PUMP MALFUNCTION. A PUMP MALFUNCTION COULD RESULT IN A FIRE, WHICH MAY RESULT IN PROPERTY DAMAGE, SERIOUS INJURY, OR DEATH.**

6. Remove the relief valve plug along with the O-Ring and shim. Not all pumps use a shim. Then remove the spring and relief valve piston.
7. Do not remove the motor assembly from the pump housing assembly.
8. Clean the housing assembly, pump plate, and pump cover assembly with any good quality spray-type carburetor cleaner. Make sure the gasket surfaces are clean. Blow parts dry with compressed air. Clean any loose Teflon sealant, etc. from the inlet and outlet ports.
9. Inspect the gerotor assembly and its corresponding contact surfaces for damage such as pits, gouges, or deep scratches. Damage and wear of this nature can greatly affect the pump's performance. Suspect components should be replaced.
10. Reassemble the pump in reverse order of the disassembly. Lubricate all friction surfaces during the assembly with WD-40 or equivalent.
11. Insert the relief valve piston into the pump cover assembly. The rubber end goes in first, followed by the spring. Replace the relief valve plug with the O-Ring, making sure to replace the small brass shim on the end, if used on your pump.
12. Turn the pump housing over and insert the gerotor assembly. Keep the same sides up.

**WARNING! MAKE SURE THE GEROTOR ASSEMBLY IS REPLACED IN THE SAME ORIENTATION AS WHEN IT WAS DISASSEMBLED. KEEP THE SAME SIDES UP.**

13. Set the large O-Ring in place on the pump housing along with the pump plate, gasket, and pump cover assembly. These parts can only be positioned one way in order for the bolt holes to align. Apply a drop of Loctite to each screw. Insert the bolts and tighten to 50-60 in./lbs. of torque.

**WARNING! OVERTIGHTENING CAN CAUSE THE PUMP BASE TO CRACK ALLOWING FUEL TO LEAK. A FUEL LEAK CAN CAUSE A FIRE AND/OR EXPLOSION, RESULTING IN PROPERTY DAMAGE, SERIOUS INJURY, AND/OR DEATH.**

14. Replace the inlet filter screens along with the fuel fittings. Teflon paste can be used on the fittings and they should be torqued to 15 ft./lbs. See the warning above.

**WARNING! DO NOT USE TEFLON TAPE ON PUMP FITTINGS. THIS TAPE CAN BREAK DOWN WHEN IT COMES IN CONTACT WITH FUEL. THE TEFLON TAPE MAY PLUG THE FUEL PUMP, CAUSING DAMAGE TO THE PUMP AND THE FUEL SYSTEM.**

15. Reinstall the pump in the vehicle.

## **CLEANING THE REGULATOR:**

1. Loosen the hex nut on the top of the regulator and back the adjusting screw out all the way to relieve tension on the diaphragm spring. See **Figure 6**.
2. Remove the four screws holding the regulator cover on. The diaphragm and spring will fall out.
3. Use a spray-type carburetor cleaner to clean the cover and regulator body. Thoroughly spray into the ports, as well as into the check ball seat area while depressing the check ball.

**WARNING! THE BRASS SEAT ASSEMBLY IS PRESSED IN AND SHOULD NOT BE REMOVED.**

4. Blow the cover and body dry with compressed air and reassemble following the diagram.
5. Be sure to readjust the fuel pressure with the adjusting screw after installing in your vehicle. Pressure adjustments must be made with the engine running.

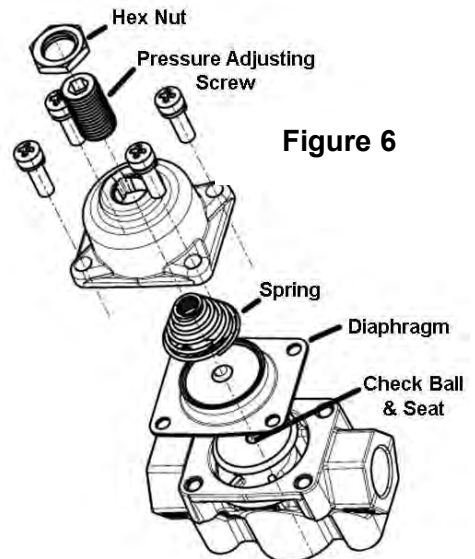

**SERVICE PARTS AND ACCESSORIES:**

<b>ITEM</b>	<b>PART NUMBER</b>
Chevy Small Block Mechanical Pump Block-Off Plate	12-814
Chevy Big Block Mechanical Pump Block-Off Plate	12-813
0-15 PSI Fuel Pressure Gauge (non-liquid filled) 1-1/2" Dia. 1/8" NPT	26-500
0-30 PSI Fuel Pressure Gauge (non-liquid filled) 1-1/2" Dia. 1/8" NPT	26-502
0-15 PSI Electric Fuel Pressure Gauge (dash mount)	26-503
0-15 PSI Fuel Pressure Gauge (liquid filled) 1-1/2" Dia. 1/8" NPT	26-504
0-30 PSI Fuel Pressure Gauge (liquid filled) 1-1/2" Dia. 1/8" NPT	26-505
90° Elbow for Attachment to Holley Fuel Line	26-69
Safety Shut Off Switch	12-810

Holley Performance Products  
Technical Support  
1801 Russellville Road  
Bowling Green, KY 42101  
Phone: 1-270-781-9741  
Fax: 1-270-781-9772

For online help, please refer to the Tech Service section of our website: [www.holley.com](http://www.holley.com)

199R10367 wf  
Date: 3-23-11