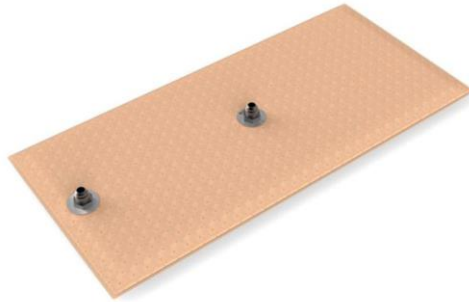


# Holley® HydraMat™

Holley® HydraMat  
P/N 12-925



## **IMPORTANT NOTES:**

### **FUEL COMPATIBILITY:**

Works with all gasoline blends (Alcohol, Ethanol, Methanol, and E-85). Not for use with oils, diesel fuels, or any other fluids.

### **NO PRE-FILTER NEEDED!**

All HydraMats are constructed with a 15 micron depth media, so no pre-filtration is required for the fuel pumps. **Use of an additional pre-filter could result in pump failure.**

### **HYDRAMAT FILTER LIFE EXPECTANCY**

The HydraMat filtration performance will provide 5-10 years or more depending on the fuel type, how clean your fuel system is, how much you drive your car, and how aggressively the car is used. Severe duty applications should inspect the filter at regular intervals to ensure the Hydramat is not restricted by debris. The Hydramat is not cleanable.

### **HYDRAMAT CLEANING**

The large majority of the debris is imbedded inside the depth media and cannot be removed. Surface cleaning is not practical or effective and should NOT be done. In extreme conditions (Racing or Off Road) check your HydraMat annually.

## HYDRAMAT INSTALLATION:

**NOTE:** The hose assembly is for reference only. This assembly is representative of a typical hose assembly if being installed using the center pick-up for a Road Course application with EFI or carburetion. This complete hose assembly can be purchased under Holley P/N LS0010ERL (includes bulkhead fittings, stat-o-seals, & feed and return hose). The side pick-up is intended for oval or circle track and the center pick-up is capped. If oval or circle track applications are being used with this HydraMat, 16-200 fuel line kit or equivalent must be purchased.

1. Lay the HydraMat out and attach an in-tank feed hose assembly on the center adapter (**Fig. 1**) and a cap on the side adapter (**Fig. 1 & 2**). Tighten the 10AN hose and cap to 360-430 in./lbs.

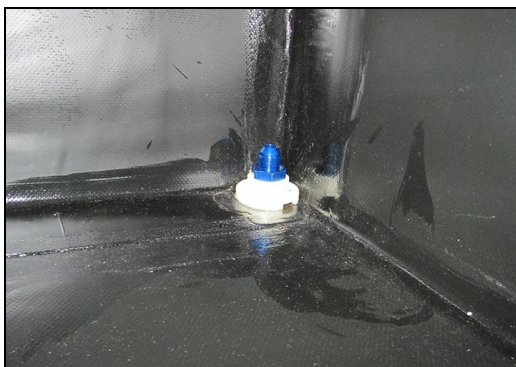


**Figure 1**



**Figure 2**

2. Drain fuel cell completely.
3. Remove the fill plate from the fuel cell. Remove foam.
4. Clean the bladder of any sediment or debris.
5. If your fuel cell has the single pickup in the right rear (passenger's side) corner, it is okay to leave this installed as it does not interfere with the HydraMat (**Fig. 3**).
6. However, if your fuel cell has a built-in surge tank (**Fig. 4**), it will need to be removed. If it cannot be removed, a new bladder without the surge tank will be required.



**Figure 3**



**Figure 4**

7. Install the HydraMat with the inlet side first toward the right rear (passenger's side). See **Figures 5-10**. Fold and feed into fuel cell toward the right rear (passenger's side) of vehicle. Make sure the blanket lays flat on the bottom of the fuel cell (**Fig. 11 & 12**).

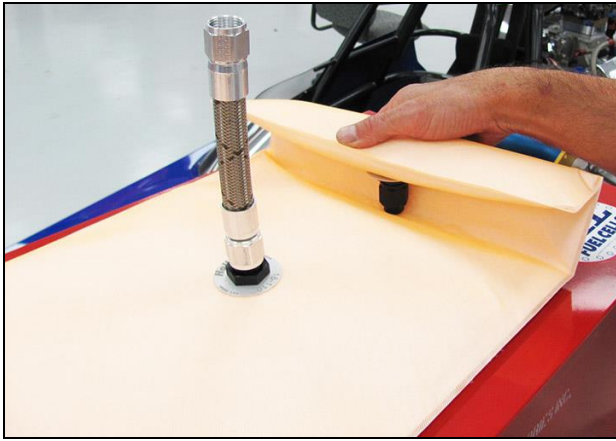


Figure 5

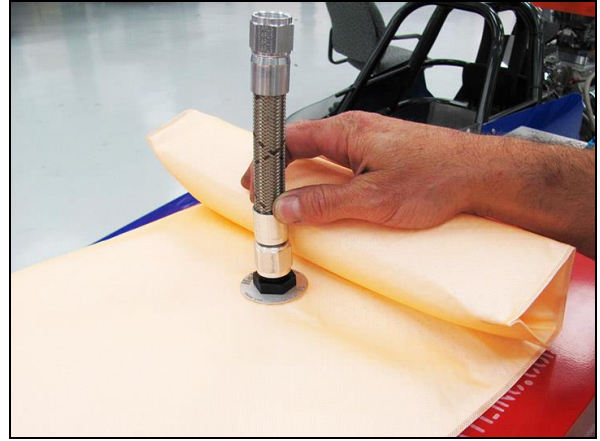


Figure 6

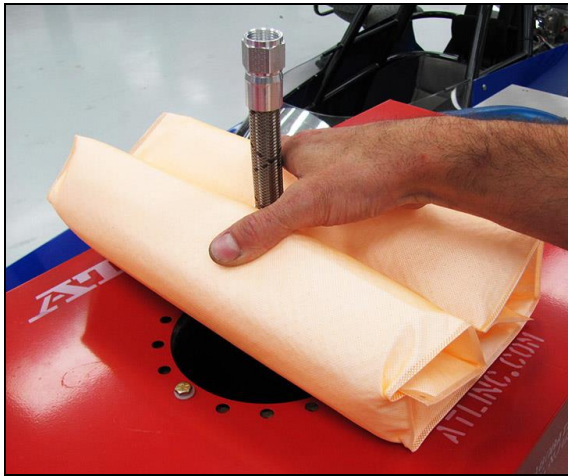


Figure 7

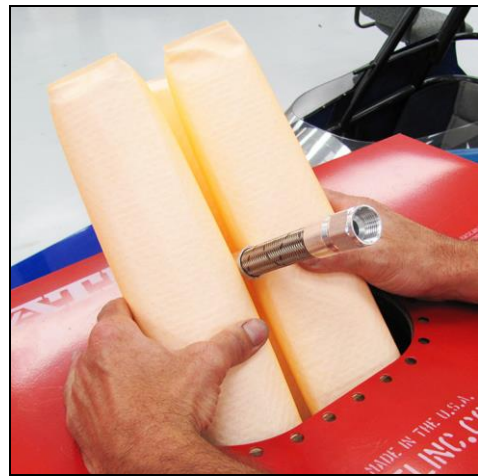


Figure 8



Figure 9

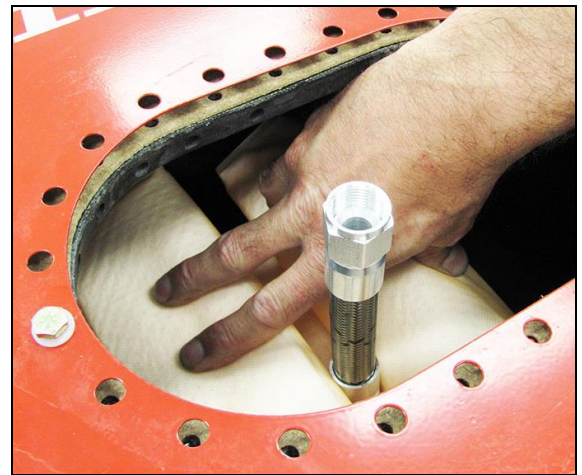


Figure 10

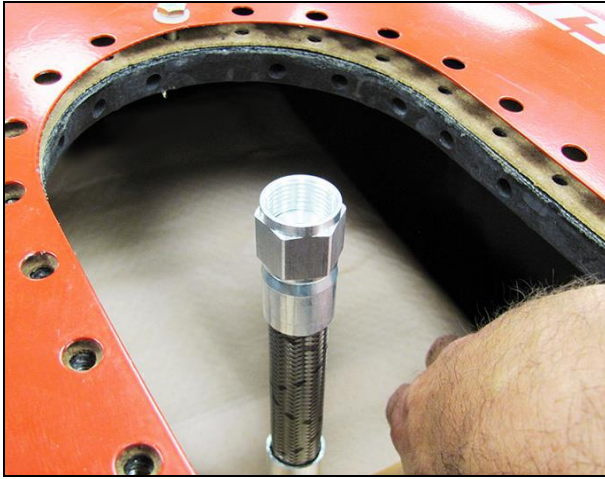


Figure 11

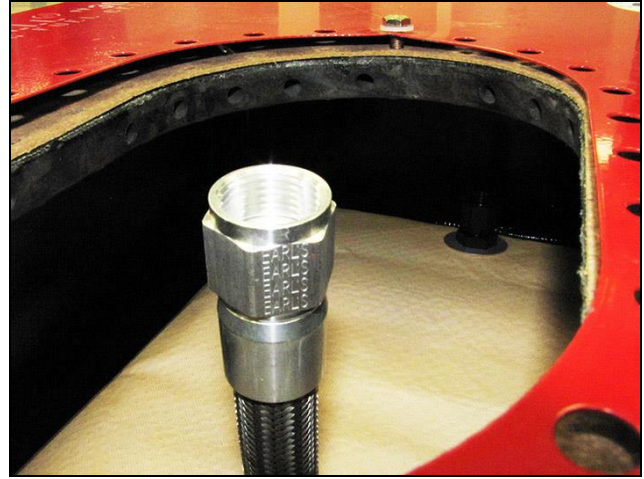


Figure 12

8. Place fill plate on the cell and measure where the feed and return hose should be placed. Drill a  $5/8$ " hole (hole on right - **Fig. 13**) for the AT983210ERL 10AN feed hose bulkhead and a  $3/4$ " hole (hole on left - **Fig. 13**) for the AT983208ERL 8AN return hose bulkhead (bulkheads included in LS0010ERL hose assembly). Make sure there is at least 3.5" center to center on the holes drilled.

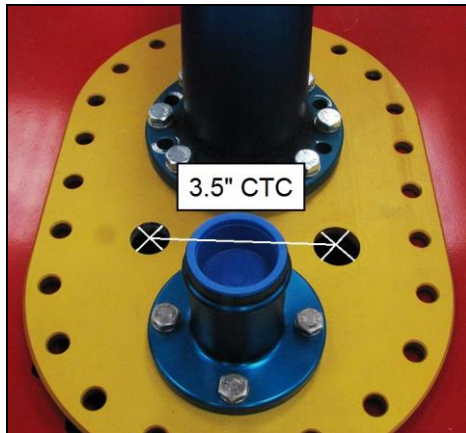


Figure 13

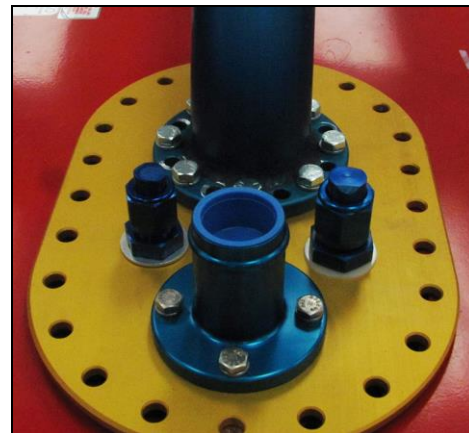


Figure 14

9. Install the bulkhead fittings (**Fig. 14**). Install the stat-o-seals (included in LS0010ERL hose assembly) or equivalent on each side of the fill plate when installing bulkhead fittings to prevent fuel leaks.
10. Install the return hose with the T-fitting to the fill plate (**Fig. 15**). Tighten the 8AN fitting to 270-350 in./lbs.

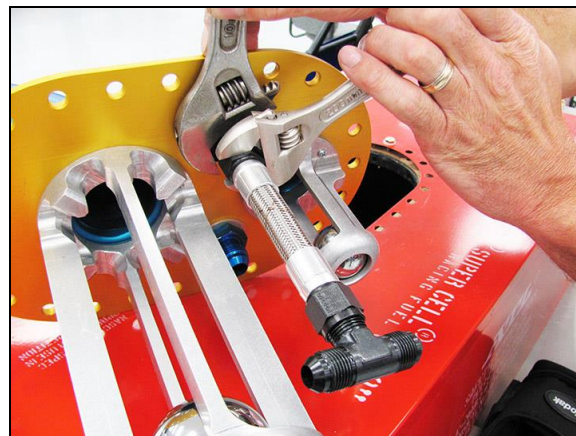


Figure 15

11. Temporarily, attach the feed hose to the bulkhead fitting in the fill plate.

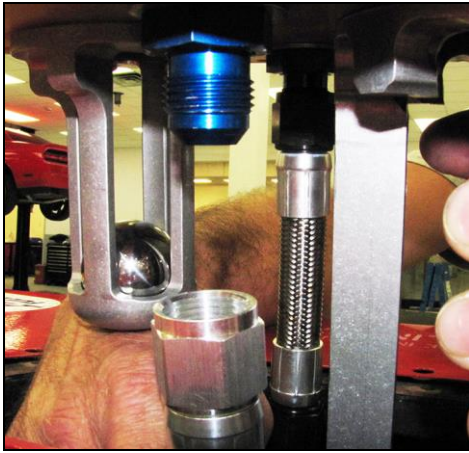


Figure 16

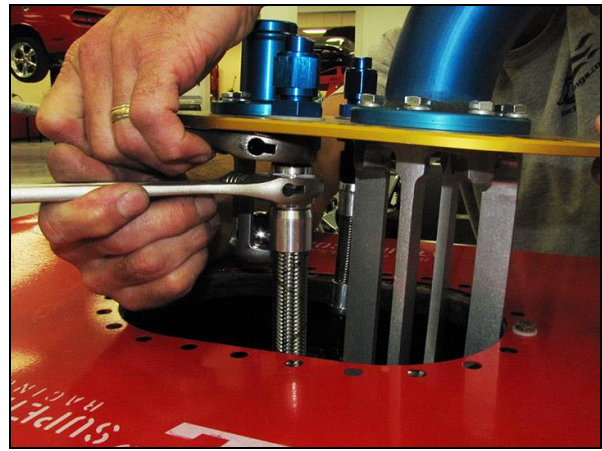


Figure 17

12. Mark and notch the foam to clear the fuel hoses, as needed (**Fig. 18**). Disconnect hoses.



Figure 18

13. Reinstall the foam into the cell.

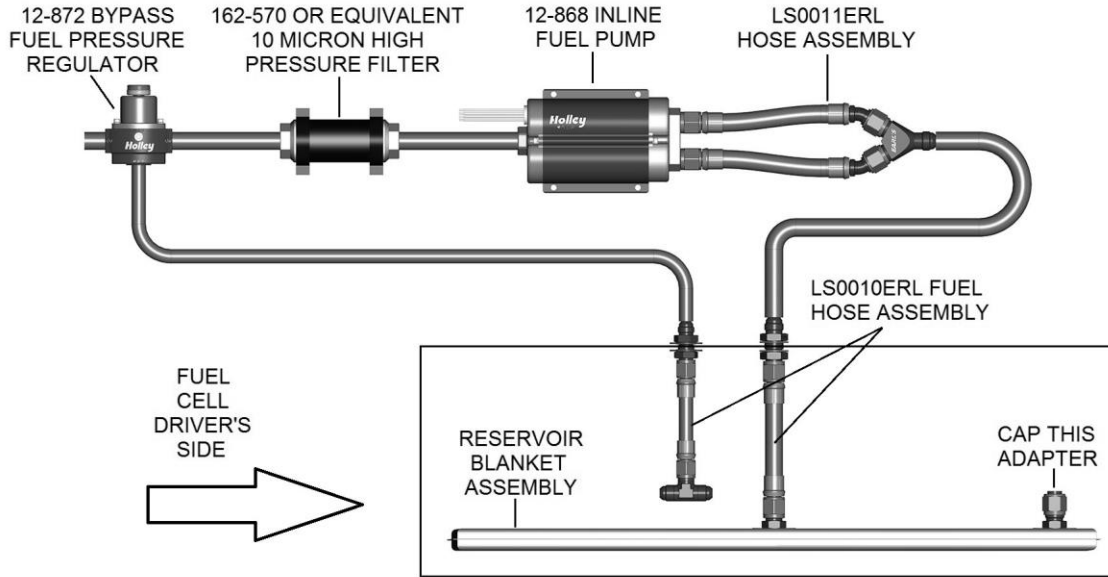
14. Attach the feed hose to the bulkhead fitting in the fill plate. Tighten the 10AN fitting to 360-430 in./lbs.

15. Verify that the HydraMat is flat with no wrinkles. Reinstall the fill plate assembly (**Fig. 19**).

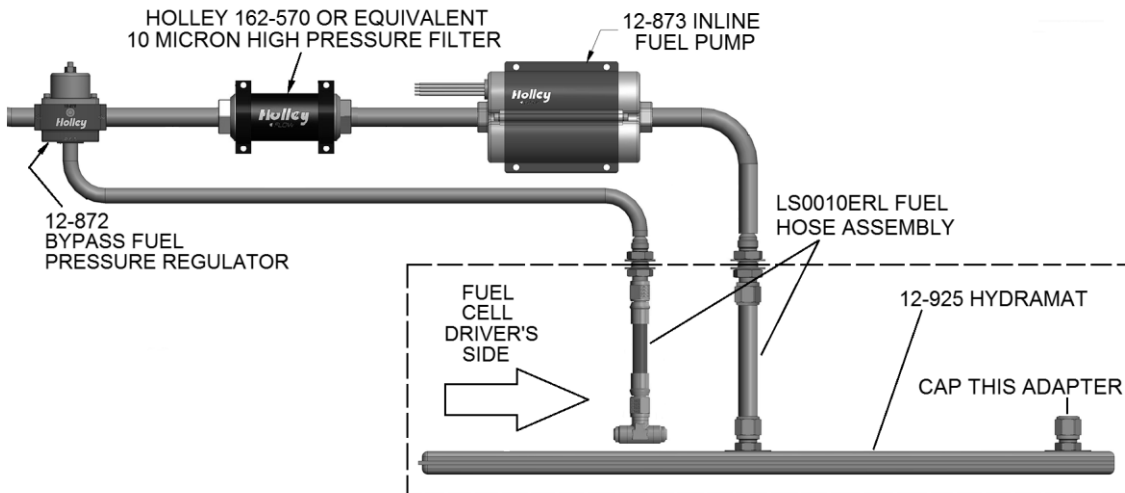


Figure 19

**NOTE: Figures 20 & 21 show how the completed HydraMat should appear after installation – tank and foam removed for clarity. The HydraMat serves as a 15 micron pre-filter to the fuel pump.**



**Figure 20 – 12-868 Fuel Pump**



**Figure 21 – 12-873 Fuel Pump**

**Holley® Performance Products**  
**1801 Russellville Road**  
**Bowling Green, KY 42101**

**1-270-781-9741**  
**1-866-464-6553**  
**www.holley.com**

© 2015 Holley Performance Products, Inc. All rights reserved.

**199R10802**  
**Revision Date: 8-6-15**