

TERMINATOR™ LS

MPFI FUEL INJECTION SYSTEM



PART NUMBERS

550-608 thru 550-615, 550-622 & 550-623

INSTALLATION & TUNING MANUAL – 199R10762

NOTE: These instructions must be read and fully understood before beginning installation. If this manual is not fully understood, installation should not be attempted. Failure to follow these instructions, including the pictures may result in subsequent system failure.

TABLE OF CONTENTS:

1.0 INTRODUCTION.....	4
2.0 WARNINGS, NOTES, AND NOTICES.....	4
3.0 PARTS IDENTIFICATION.....	5
4.0 ADDITIONAL ITEMS REQUIRED FOR INSTALLATION.....	5
5.0 TOOLS REQUIRED FOR INSTALLATION.....	6
6.0 REMOVAL OF EXISTING COMPONENTS.....	6
7.0 TERMINATOR MPFI SYSTEM INSTALLATION.....	6
7.1 Fuel Pump, Fuel Line, and Filter Installation.....	6
7.2 Oxygen Sensor Installation.....	6
7.2.1 Oxygen Sensor Mounting Procedure.....	7
7.3 ECU Mounting.....	7
8.0 WIRING.....	7
8.1 Important Wiring "Do's and Don'ts".....	7
9.0 WIRING HARNESS INSTALLATION.....	8
9.1 Main Power/Battery Connection.....	8
10.0 PRIMARY HARNESS INSTALLATION AND SENSOR CONNECTIONS.....	8
10.1 ECU Connectors.....	9
10.2 Harness Routing.....	9
10.3 Sensor Connections & Outputs.....	10
10.3.1 Oil Pressure Sensor.....	10
10.3.2 Coolant Temperature Sensor (CTS).....	10
10.3.3 Wide Band Oxygen Sensor (WB02).....	10
10.3.4 Fuel Pressure (Fuel).....	10
10.3.5 Manifold Air Temperature (MAT).....	11
10.3.6 Cam Sensor.....	11
10.3.7 Crank Sensor.....	11
10.3.8 Knock Sensors.....	12
10.3.9 Manifold Absolute Pressure sensor (MAP).....	12
10.3.10 Throttle Position Sensor (TPS).....	12
10.3.11 Idle Air Control (IAC).....	12
10.3.12 Fuel Injectors.....	13
10.3.13 Ignition Coils.....	13
10.3.14 Coil Ground Wires.....	13
10.3.15 Handheld Connections - (CAN1).....	14
11.0 LOOSE WIRES.....	15
12.0 ADDITIONAL OUTPUTS.....	15
13.0 TRANSMISSION HARNESS.....	16
13.1 Transmission Wiring.....	16
14.0 DRIVE-BY-WIRE HARNESS.....	17
14.1 Overview.....	17
14.2 Warnings!.....	17
14.3 Installation.....	17
14.4 System Safeties.....	18
14.5 Throttle Body "Limp Home" Position.....	18
14.6 Drive-By-Wire DO'S and DON'TS.....	18
14.7 Wiring.....	18
APPENDIX 1.0 PINOUT.....	19
15.0 PREVIOUS INSTALLATION REQUIRED.....	19
16.0 TERMINATOR™ INSTRUCTIONS AND TUNING.....	19
17.0 INITIAL POWER-UP.....	19
18.0 HANDHELD NAVIGATION & USE.....	20
18.1 Making Adjustments.....	20
19.0 HOME SCREEN.....	21
20.0 CALIBRATION WIZARD.....	22
21.0 TPS AUTOSET.....	24
22.0 TRANSMISSION SETUP.....	25
22.1 Transmission.....	25
22.1.1 Trans Setup.....	25
22.1.2 Speed Calc.....	25
23.0 SENSOR VERIFICATION.....	26
24.0 STARTUP.....	26
25.0 AFTER-STARTUP.....	26
26.0 IDLE SETTING/CABLE OPERATED THROTTLE PLATE SETTING.....	27
27.0 SELF-TUNING.....	27
28.0 GAUGE SCREENS.....	28
28.1 Monitor.....	28
28.1.1 Multi-Gauge.....	28
28.1.2 Monitors.....	29

28.1.3 Diagnostics.....	29
29.0 Custom Setups.....	30
29.1 Dash Setup.....	30
29.2 Channels Scaling.....	30
30.0 FILE SAVING/LOADING	30
30.1 File.....	31
30.1.1 ECU Overview.....	31
30.1.2 ECU Globals	31
30.1.3 ECU Data Logging	32
30.1.4 ECU Hardware/Firmware (HW/FW)	32
30.1.5 Local Setup	32
31.0 BASIC TUNING.....	33
31.1 Basic Fuel.....	33
31.1.1 Target AFR.....	33
31.1.2 Acceleration Enrichment	34
31.1.3 Fuel Prime.....	34
31.2 Fuel Learn	35
31.2.1 Learn Enable/Disable	35
31.2.2 Learn Speed.....	35
31.3 Basic Idle.....	35
31.4 Spark	36
31.5 Transmission	36
31.5.1 Shifts	36
31.5.2 WOT Shifts.....	37
31.5.3 Torque Converter Clutch (TCC) Parameters.....	37
31.5.4 Torque Converter Clutch (TCC) (Un) Lock.....	38
31.5.5 Line Pressure	39
31.6 Drive-By-Wire	39
31.6.1 Pedal vs Throttle	39
32.0 SYSTEM SETUP.....	40
32.1 System Tuning.....	40
32.1.1 Outputs.....	40
32.1.2 Engine Setup.....	40
32.1.3 Ignition Setup	41
33.0 ADVANCED TUNING.....	42
33.1 Advanced Fuel.....	42
33.2 Closed Loop	43
33.3 Advanced Learn	44
33.4 Advanced Idle	44
33.4.1 IAC Rampdown	44
33.4.2 IAC Speed.....	45
33.4.3 IAC Startup.....	45
33.4.4 Idle Spark	46
APPENDIX 2.0 INJECTOR GROUPINGS AND INJECTOR CONNECTOR INFORMATION	46
Injector Groups.....	46
Injector Connectors	48
EV1	48
EV6 / USCAR.....	49
MULTEC 2	49
APPENDIX 3.0 THROTTLE BODIES AND PEDALS	50
6 PIN CONECTOR:	50
8 PIN (EARLY TRUCK) CONNECTOR:	51
Throttle Pedal	51
APPENDIX 4.0 SENSOR DIAGNOSTICS AND STATUSES	51

1.0 INTRODUCTION

Holley Performance Products has written this manual for the installation of the **LS TERMINATOR™ MPFI** fuel injection system. This manual contains the information necessary for the installation of the hardware contained in this kit, which includes the ECU, wiring, and 3.5" touch screen. It also contains all tuning information. This instruction sheet does not include installation instructions for the fuel system (pump, filters, regulators and lines). Please read all the **WARNINGS** and **NOTES**, as they contain valuable information that can save you time and money. It is our intent to provide the best possible products for our customer; products that perform properly and satisfy your expectations. Should you need information or parts assistance, please contact our technical service department at 1-270-781-9741, Monday through Friday, 8 a.m. to 5 p.m. Central Time. By using this number, you may obtain any information and/or parts assistance that you may require. Please have the part number of the product you purchased when you call.

2.0 WARNINGS, NOTES, AND NOTICES

NOTE: This system does not contain fuel system components that are required including the fuel pump, fuel filters, fuel pressure regulator, and lines. Holley offers complete kits can be purchased separately (526-1, 526-2, 526-3, & 526-4).

NOTE: This system is designed for stock and mild cam, naturally aspirated LS engines.

WARNING! The **LS TERMINATOR MPFI** systems consist of a number of sophisticated components. Failure of any one component does not constitute, nor does it justify, warranty of the complete system. Individual service items are available for replacement of components. If assistance is required or if you need further warranty clarification, you can call Holley Technical Service at the number shown above.

WARNING! To preserve warranty, these instructions must be read and followed thoroughly and completely before and during installation. It is important that you become familiar with the parts and the installation of the **LS TERMINATOR MPFI** system before you begin. Failure to read and understand these instructions could result in damage to **LS TERMINATOR MPFI** components that are not covered by the warranty and could result in serious personal injury and property damage.

WARNING! The oxygen sensor in this kit is recommended for use with **ONLY** unleaded fuel. Use of leaded fuels will degrade the oxygen sensor and will result in incorrect exhaust gas oxygen readings and improper fuel delivery. Failure to follow these directions does not constitute the right to a warranty claim.

WARNING! Failure to follow all of the above will result in an improper installation, which may lead to personal injury, including death, and/or property damage. Improper installation and/or use of this or any Holley product will void all warranties.

WARNING! Use of some RTV silicone sealers will destroy the oxygen sensor used with this product. Ensure the RTV silicone sealant you use is compatible with oxygen sensor vehicles. This information should be found on the RTV package.

WARNING! For the safety and protection of you and others, only a trained mechanic having adequate fuel system experience must perform the installation, adjustment, and repair. It is particularly important to remember one of the very basic principles of safety: fuel vapors are heavier than air and tend to collect in low places where an explosive fuel/air mixture may be ignited by any spark or flame resulting in property damage, personal injury, and/or death. Extreme caution must be exercised to prevent spillage and thus eliminate the formation of such fuel vapors.

WARNING! This type of work **MUST** be performed in a well-ventilated area. Do not smoke or have an open flame present near gasoline vapors or an explosion may result.

3.0 PARTS IDENTIFICATION

<u>ITEM</u>	<u>DESCRIPTION</u>	<u>QTY</u>	<u>SERVICE PART</u>
1A	TERMINATOR™ EFI ECU (Kits 550-608, 610 & 614)	1	554-113
1B	TERMINATOR™ EFI ECU (Kits 550-609, 611, 612, 613, 615, 622, 623)	1	554-114
2	TERMINATOR Hand-Held Controller	1	553-108
3	Main Power Harness	1	558-308
4A	Main Engine Harness (Kits 550-608, 609 & 550-614 thru 550-623)	1	558-102
4B	Main Engine Harness (Kits 550-610 thru 550-613)	1	558-103
5A	Injector Harness (Kits 550-608 & 550-609)	1	558-200
5B	Injector Harness (Kits 550-610 thru 550-613)	1	550-201
5C	Injector Harness (Kits 550-614, 615, 622 & 623)	1	558-214
6	Input/Output Harness	1	558-400
7A	Drive-By-Wire Harness (Kits 550-611 & 550-613)	1	558-406
7B	Drive-By-Wire Harness – Early Truck (Kits 550-615 & 550-623)	1	558-429
8	4L60e/4L80e Transmission Harness	1	558-405
9	CAN Power Harness	1	558-430
10	CAN Extension Harness	1	558-424
11	Oxygen Sensor	1	554-101
12	Oxygen Sensor Weld Ring	1	534-49
<u>Service Parts:</u>			
13	40 AMP Relay	1	534-26
<u>Optional Parts:</u>			
14	100 PS Fuel Pressure Sender	1	554-102



4.0 ADDITIONAL ITEMS REQUIRED FOR INSTALLATION

- Fuel System
- Return Fuel Lines

A 0-100 psi fuel gauge or pressure transducer is recommended to check for proper fuel pressure. PN 554-102 is a 0-100 PSI pressure sensor that can be purchased as well that will plug into the TERMINATOR™ harness to check and monitor fuel pressure. It requires a 1/8" NPT port for installation (Holley fuel pressure regulators have an 1/8" NPT port)

These kits are designed to use factory sensors and injectors. Any deviation from this may require different harnesses. Please contact Holley Technical Services if your project is using any non-OEM parts.

5.0 TOOLS REQUIRED FOR INSTALLATION

- Standard wrench set
- Medium blade screwdriver
- Drill and assorted bit sizes
- Factory Service Manual for your vehicle
- Small blade screwdriver
- #2 Phillips screwdriver
- Hole saw (2") (depending on ECU location)
- 02 Bung Installation (drilling, welding)
- Allen Wrench set
- Digital Volt meter
- Terminal crimping tool

An assistant is necessary for some installation and adjustment procedures and should be present for safety reasons.

6.0 REMOVAL OF EXISTING COMPONENTS

1. Disconnect the battery.
2. Remove the existing OEM main wiring harness and injector harness. Consult the factory service manual for details on how to properly remove the harness.

7.0 TERMINATOR MPFI SYSTEM INSTALLATION

7.1 Fuel Pump, Fuel Line, and Filter Installation

A complete high pressure EFI fuel system must be installed for the TERMINATOR™. The pump should be capable of supplying 255 liters/hour or 400 lb./hr. of fuel at 45 PSI. If using an in-line fuel pump, there should be a coarse pre-filter before the pump. All systems should contain a 10 micron post filter after the fuel pump. An EFI fuel pressure regulator is required. It should be installed after the throttle body. See **Figure 4** below for proper fuel system plumbing.

Holley offers four fuel system kits. These kits contain all components except the return line. They include detailed instructions (downloadable at www.holley.com). These kits are:

- 526-1 – Braided Stainless Lines, Billet Pump, Regulator, and Filters
- 526-2 – Pro-Lite 350 Hose, Billet Pump, Regulator, and Filters
- 526-3 – Super Stock Hose, Billet Regulator, 12-920 Fuel Pump, and Filter
- 526-4 – Super Stock Hose, Billet Regulator, 12-920 Pump, and Metal Filters

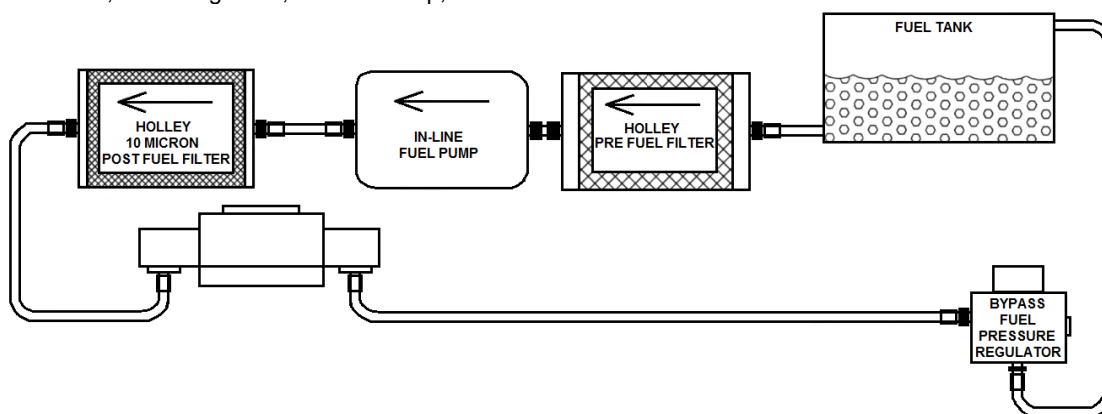

Figure 4

7.2 Oxygen Sensor Installation

The oxygen sensor should be mounted at a point where it can read a good average of all the cylinders on one bank. This would be slightly after all the cylinders merge. Do NOT mount the sensor far back in the exhaust as this will negatively impact closed loop operation response. If you have long tube headers, mount the sensor approximately 1-10" after the collector. You must have no less than 18 – 24" of exhaust pipe after the sensor.

TERMINATOR™ EFI systems come with a Bosch wideband oxygen sensor (**Item 5**). Make sure your sensor looks like **Figure 5**.



Figure 5

7.2.1 Oxygen Sensor Mounting Procedure

NOTE: Never run the engine with the oxygen sensor installed if it is not plugged in and powered by the ECU, or it will be damaged. If you need to plug the hole temporarily, use an O₂ sensor plug or a spark plug with an 18mm thread.

NOTE: Someone with experience in welding exhaust systems should install the oxygen sensor boss. Any competent exhaust shop will be able to perform this task at a minimum cost. (Note: If you weld on the car, make sure all wiring to the ECU is disconnected, and its best to remove the ECU from the vehicle when welding).

WARNING! Use of leaded fuel will degrade an oxygen sensor. Prolonged use is not recommended unless periodic replacement is performed.

WARNING! Use of some RTV silicone sealers will destroy the oxygen sensor used with this product. Ensure the RTV silicone sealant you use is compatible with oxygen sensor vehicles. This information should be found on the RTV package.

1. Locate a position for the oxygen sensor as close to the engine as possible. If your vehicle has catalytic converters, the oxygen sensor MUST be located between the engine and the catalytic converters.

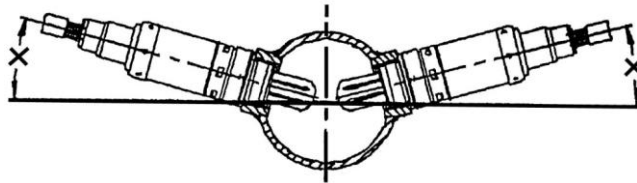

Figure 6

NOTE: The oxygen sensor should be mounted in such a way that the condensation in the exhaust tubing will not enter the sensor. Mount the O₂ sensor in the upper half of the exhaust tubing, with the angle “x”, shown above, being greater than 10°. **Figure 6** indicates that the sensor can be mounted on either side of the exhaust tubing.

2. Drill a 7/8” hole in the location picked for the sensor. Weld the threaded boss into the 7/8” hole. Weld all the way around the boss to insure a leak proof connection. Install the oxygen sensor into the threaded boss and tighten securely. It is a good idea to add anti-seize to the threads to aid in removal. Do not get any anti-seize on the tip of the sensor.
3. On vehicles equipped with an AIR pump, the oxygen sensor must be mounted before the AIR injection into the exhaust, or the AIR pump must be disconnected. Holley recommends that if the AIR is injected into both exhaust manifolds, mount the oxygen sensor into the pipe immediately after the exhaust manifold. Disconnect the AIR pump tube from the exhaust manifold and plug both ends. Check with local ordinances for the legality of this procedure in your area.

WARNING! Failure to disconnect the AIR pump or locating the oxygen sensor downstream from AIR injection will result in an extremely rich mixture, which could cause drivability problems and severe engine damage.

7.3 ECU Mounting

The ECU can be mounted inside the passenger compartment (preferable location) or in the engine compartment. If mounted in the engine compartment, follow these guidelines:

- The ECU should be located such that it isn't being directly hit by water or road debris.
- It should also be located such that it isn't extremely close to exhaust manifolds or headers.
- It should be mounted such that it is as far away from spark plug wires, CD ignition boxes, or other “electrically noisy” devices as is reasonable possible.
- Make sure the connector end of the ECU is pointed DOWN such that water can't make its way into the ECU terminals.

The ECU comes with mounting hardware (stainless steel screws and nuts). The ECU has plastic shoulders on the mounting ears. DO NOT REMOVE THEM. Do not over-tighten the mounting hardware if the ECU is not mounted on a flat surface.

8.0 WIRING

This section overviews how to properly install the wiring harnesses for this system.

8.1 Important Wiring “Do’s and Don’ts”

An EFI system depends heavily on being supplied a clean and constant voltage source. The grounds of an electrical system are just as important as the power side.

TERMINATOR™ ECU's contain multiple processing devices that require clean power and ground sources. The wiring harnesses for them must be installed in such a manner that they are separated from “dirty” power and ground sources.

DO'S

- Install the main power and ground directly to the battery. To the POSTS/TERMINALS, not to any other place.
- Keep sensor wiring away from high voltage or “noisy/dirty” components and wiring, especially secondary ignition wiring (plug wires), ignition boxes and associated wiring. It is best that the plug wires not physically contact any EFI wires.
- Properly crimp or crimp and solder any wire connections. Apply quality heat shrink over any of these connections.
- It is critical that the engine has a proper ground connection to the battery and chassis.

DON'TS

- NEVER run high voltage or “noisy/dirty” wires in parallel (bundle/loom together) with any EFI sensor wiring. If wires need to cross, try to do so at an angle.
- Do not use the electric fan outputs to directly power a fan. They must only trigger a relay.
- Do not use improper crimping tools.
- Don't use things like “t-taps”, etc. Use proper crimpers/solder and heat shrink.
- It is never recommended to splice/share signal wires (such as TPS, etc.) between different electronic control units (i.e. “piggyback”).
- Do not connect the red/white switched +12V wire to “dirty” sources, such as the ignition coil, audio systems, or 12V sources connected to HID head lamps.

9.0 WIRING HARNESS INSTALLATION

9.1 Main Power/Battery Connection

The TERMINATOR™ ECU has a main battery power and ground connector on the right side of the ECU. The bottom position, Terminal “A” is the ground (black wire). The black wire should go to the negative post DIRECTLY on the battery. The upper position, Terminal “B” is the positive terminal (red wire). The red wire should go to the positive post DIRECTLY on the battery. If you have a “dual post” battery, it is a great idea to purchase separate posts/studs to connect the ECU power and ground to the non-used terminals. Always use the fused power cable (**Item 3**) with the proper connectors supplied by Holley only. Don't connect to the ECU until after ALL wiring and installation is performed.



Figure 7

10.0 PRIMARY HARNESS INSTALLATION AND SENSOR CONNECTIONS

These sections review the Main Harness installation and sensor connections that must be completed. The Main Harness (**Item 4**) is the primary harness that supports all the primary engine sensors, fuel and ignition. There are two main connectors for this harness that plug into the ECU.

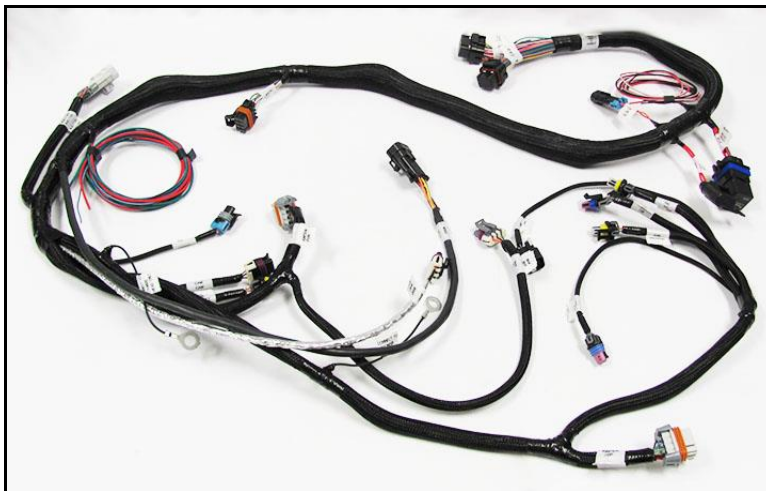

Figure 8

10.1 ECU Connectors

TERMINATOR™ ECU – The TERMINATOR™ ECU has **two** main connectors:

- **J1A** - The first connector next to the USB connector is the “J1A” connector (34 pin). This connector is primarily an “Input” connector. It contains all the sensor inputs and wide band oxygen sensor control.
- **J1B** - The second connector is the “J1B” connector (26 pin). This connector is the “output” connector. It has 8 injector outputs and outputs for other devices.
- **J2A** – Not used with Terminator kits.
- **J2B** – Not used with Terminator kits.
- **J3** – Connection point for the Drive-By-Wire harness.
- **J4** – Connection point for the Transmission harness



**BAROMETRIC PRESSURE SENSOR
(NO CONNECTION NEEDED)**

The ECU above is used in Kits 550-608, 550-610 & 550-614

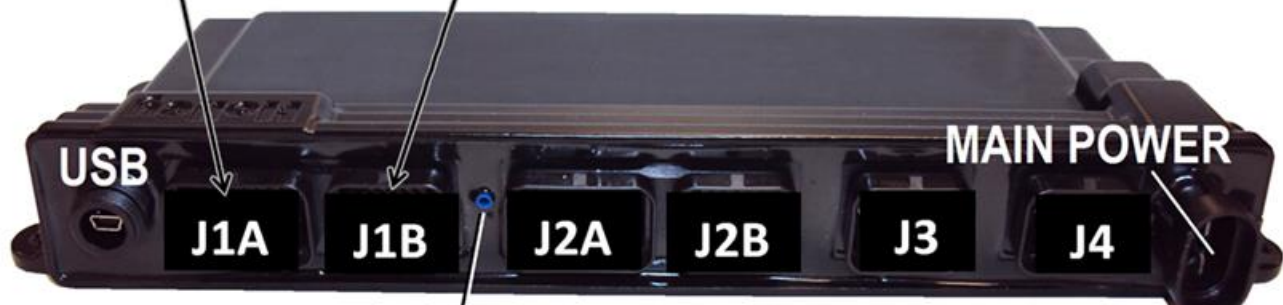
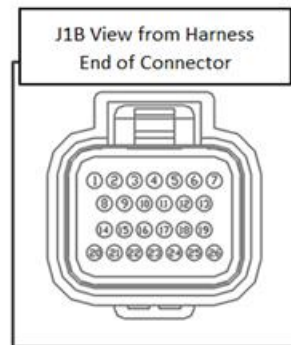
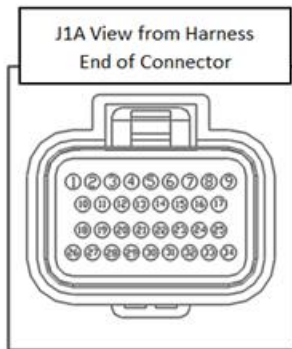

**BAROMETRIC PRESSURE SENSOR
(no connection needed)**

The ECU above is used in kits 550-609, 550-611, 550-612, 550-613, 550-615, 550-622, 550-623
(*USB is not used on TERMINATOR EFI)

10.2 Harness Routing

If the ECU is mounted in the interior, it will have to be routed through the firewall into the engine compartment. Use a 2” hole saw to create a hole in a desired location if no other point of access is available. A grommet is supplied for a 2” hole to seal this area.

If the ECU is mounted in the engine compartment, the 3.5" Touch Screen cable will have to be routed to the "CAN" connector on the main harness (located near the ECU connector main connector). This is assuming you want to access the hand-held module after startup. This will require routing the small CAN connector somewhere through the firewall.

Connect the J1A and J1B connectors of the main harness into the ECU.

About 18" from the ECU main connectors is a 40A Relay. This powers the injectors and fuel pump. There is also a 20 amp fuse for the injectors and fuel pump pre-installed in this location.

10.3 Sensor Connections & Outputs

The following indicates the primary sensors that are required to be connected. Each connector on the main harness is labeled with the sensor name. The name on this label for each sensor is in parenthesis below.

10.3.1 Oil Pressure Sensor

Connect to the factory Oil Pressure sensor, located at the rear of the engine.



Figure 9 Oil Pressure

10.3.2 Coolant Temperature Sensor (CTS)

Connect the CTS connector to the sensor which should be located in the front of the driver's side cylinder head.



Figure 10 CTS

10.3.3 Wide Band Oxygen Sensor (WB02)

Connect to the oxygen sensor previously installed. If you need an extension cable, one is available from Holley (P/N 534-199). The TERMINATOR™ systems are intended to be used with a Bosch wide band oxygen sensor supplied by Holley.

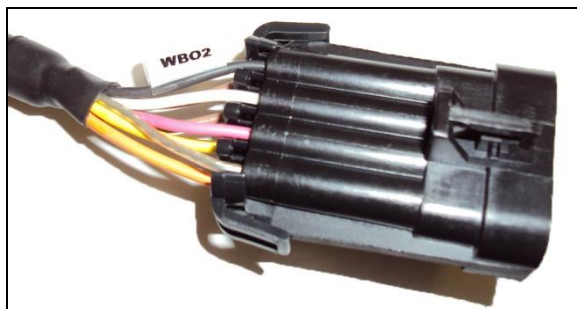

Figure 11 WB02

10.3.4 Fuel Pressure (Fuel)

A fuel pressure transducer connector is pre-installed in the main harness. The system is plug-and-play configured for a Holley 100 PSI pressure transducer (can be purchased under PN 554-102). If these are not connected to a pressure transducer, the Fuel Pressure shown on the hand held display will not be accurate. This will not cause any issues. Connect to the transducer (if installed).

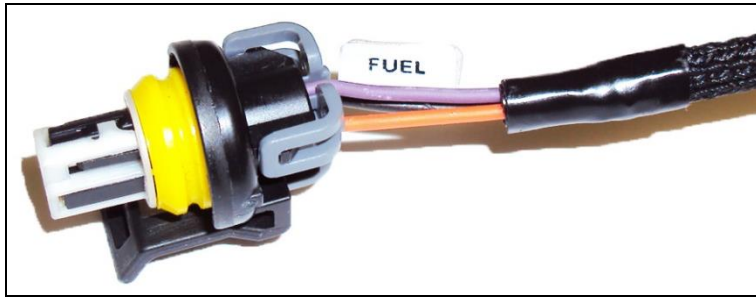

Figure 12 Fuel Pressure

10.3.5 Manifold Air Temperature (MAT)

Connect to the MAT sensor located on the intake manifold.

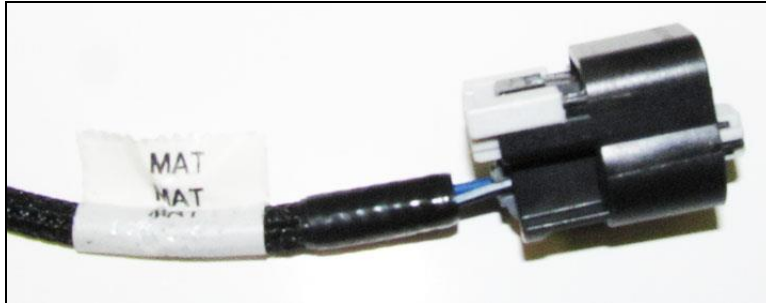

Figure 13 MAT

10.3.6 Cam Sensor

The cam sensor is located in two different locations, depending on whether the harness is for a 24x or 58x crankshaft. If 24x, the camshaft position sensor is located at the top, rear of the block, at the back of the intake manifold. If 58x, the cam sensor is located in the timing cover on the driver's side. The Holley harness plugs directly into the sensor, not the short pigtail that may be on the engine.



Figure 14 Cam Sensor

10.3.7 Crank Sensor

The crank sensor should be bundled in some reflective heat shielding. The crank sensor is located behind the starter. Connect to the crankshaft position sensor.



Figure 15 Crank Sensor

10.3.8 Knock Sensors

Connect to the Knock Sensor(s). Earlier model LS engines will have a knock sensor located in the center valley of the engine. Later model LS engines have knock sensors located on the bottom of the block near the oil pan rails.

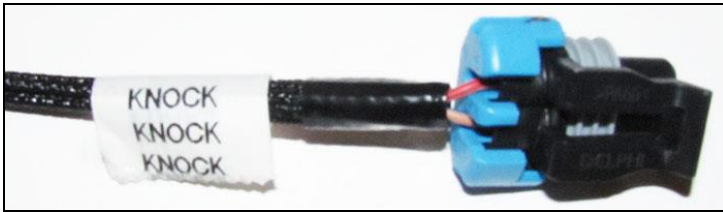

Figure 16 Knock

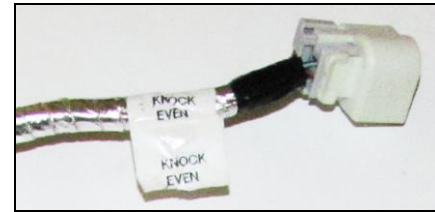

Figure 17 Knock Even

10.3.9 Manifold Absolute Pressure sensor (MAP)

Connect to the MAP sensor located on the intake manifold. Later model LS3 engines will require use of the MAP adapter (558-416) included with the TERMINATOR kit (Figure 19).

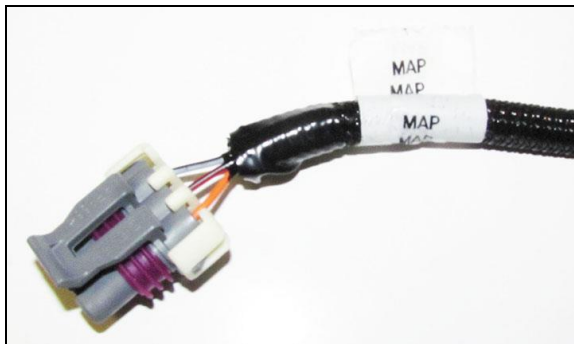

Figure 18 MAP



Figure 19 MAP Adapter

10.3.10 Throttle Position Sensor (TPS)

Connect to the cable driven throttle body.

Note: This connector is not used with a Drive-By-Wire throttle body



Figure 20 TPS

10.3.11 Idle Air Control (IAC)

Connect to the cable driven throttle body.

Note: This connector is not used with a Drive-By-Wire throttle body

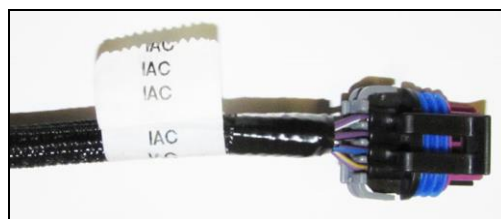

Figure 21 IAC

10.3.12 Fuel Injectors

The fuel injector harness is labeled by cylinder. Please refer to **Figure 23** below for proper LS cylinder number identification.

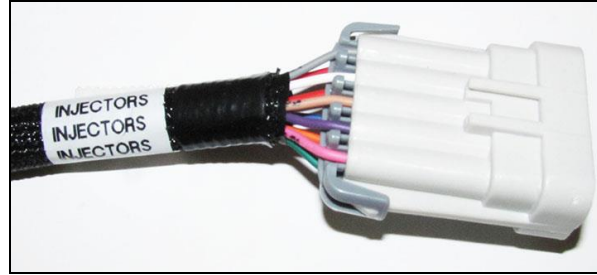

Figure 22 Fuel Injectors

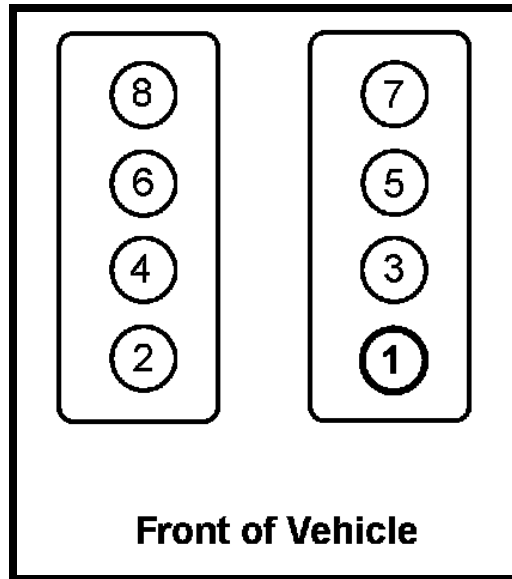

Figure 23

NOTE: Make sure to connect these to the appropriate fuel injector otherwise severe engine damage may occur.

NOTE: Since their introduction, LS engines have been shipped from the factory with 3 different styles of fuel injector connectors. An overview of these various connector styles can be found in Appendix 2.0. If the harness supplied in your kit does not match what your engine has, please contact Holley Tech Service.

10.3.13 Ignition Coils

Connect the coil connectors into each bank of coils. The driver side connector should be labeled "DIS CONNECTOR ODD". The passenger side connector should be labeled "DIS CONNECTOR EVEN". Make sure these are plugged in correctly. If they aren't, the firing order will not occur properly and damage could result.

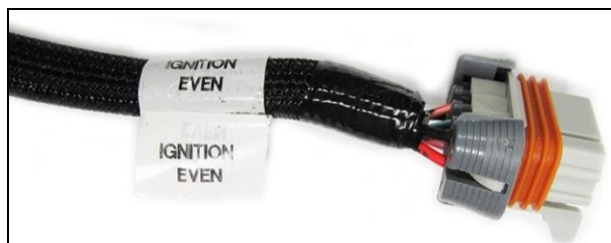

Figure 24 Ignition Even

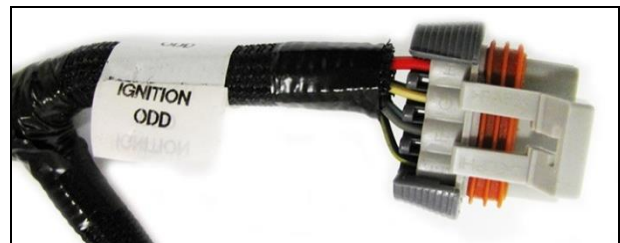

Figure 25 Ignition Odd

10.3.14 Coil Ground Wires

There are two coil ground wires. These are labeled "CONNECT TO CLYNDER HEAD ONLY!" There is one on each bank of the engine. They are black wires and have an eyelet crimped on them. These are to be fastened to the rear of each cylinder head. These **MUST** be installed and **MUST** be installed to the head securely. If not, the coils will not be grounded and the engine will run poorly and other issues will occur.



Figure 26 Coil Ground Wires

10.3.15 Handheld Connections - (CAN1)

The handheld controller is used to create an initial calibration for the system, allows for simple tuning changes to be performed, and is also used to view various information of the EFI system. It should be installed such that the handheld controller can be easily used in the passenger compartment. The CAN Power harness (Figure 30) has two loose wires, the white wire should be connected to a switched +12v ignition source, and the black wire to ground. Plug the other end of the CAN power harness into the main wiring harness at the plug marked "CAN" (Figure 27). This plug is located 21 inches from the ECU connector. A 4' CAN extension harness (packaged with the handheld) is used to connect between the handheld and the CAN power harness. The handheld has a dual connector which allows the product to be connected to multiple devices on the CAN bus (Figure 29). The CAN extension harness may be plugged into either side of the dual handheld connector. The handheld does not have to remain in the vehicle or utilized after the vehicle is set up and running properly.

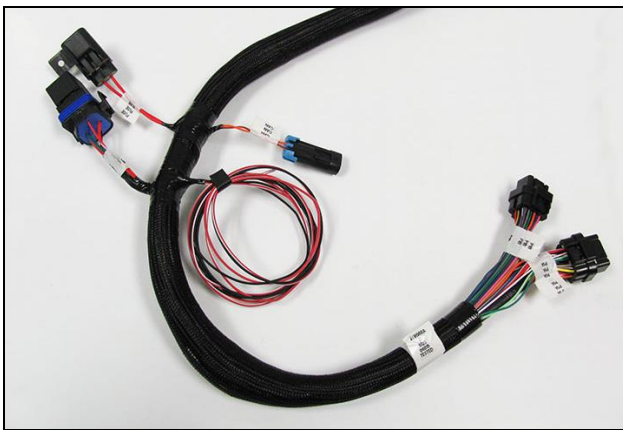

Figure 27



Figure 28 Handheld

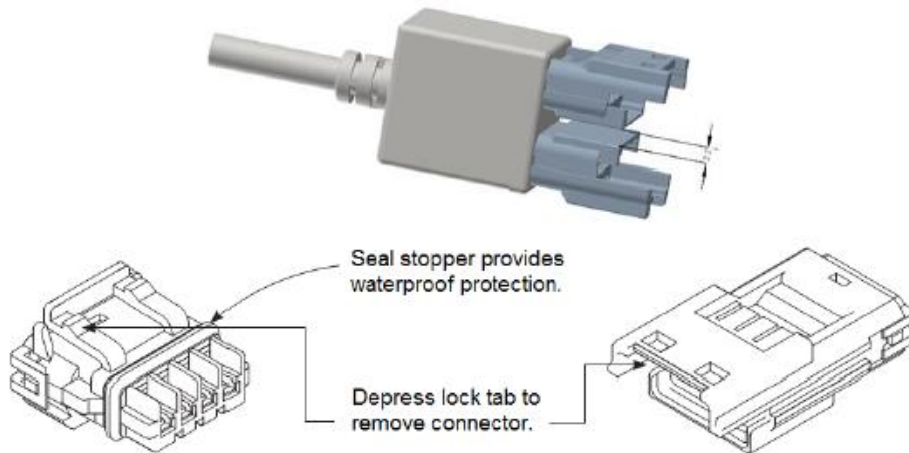

Figure 29 – Handheld dual CAN connector



Figure 30 - CAN Power Harness

Pin	Function	Color	Description
1	+12V	WHT	Main power in
2	CAN1H	ORG/BLK	CAN H Holley EFI communications
3	CAN1L	ORG	CAN L Holley EFI communications
4	GND	BLK	GND

Figure 31 - CAN Power Harness wiring

11.0 LOOSE WIRES

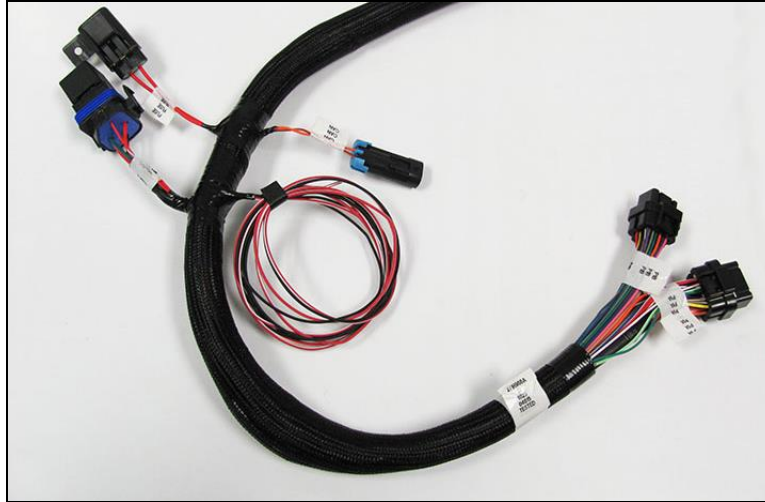

Figure 32

The following loose wires in the main wiring harness should be connected as follows on all systems. All of these wires come out of the harness about 40" from the ECU connectors except for the "12V Switched" wire.

12V Switched – Color = Red/White – Should be connected to a clean +12 volt power source. Power source should only be active when the ignition is on. Make sure source has power when engine is cranking as well (check with voltmeter). Not all sources apply power when the ignition switch is in "cranking" position. This wire is located approximately 7" from the ECU connectors. **DO NOT connect to a "DIRTY" source like an ignition coil!**

12V Battery – Color = Red – Should be connected directly to the battery. This powers the fuel pump and fuel injectors. This wire is protected by a fuse in a sealed fuse holder. The fuse holder is located about 18" from the ECU connector. A fuse is pre-installed (20A).

12V Fuel Pump – Color = Green - Used to directly power a fuel pump (+12 volt). Do not use this wire to power fuel pumps that require over 15 Amps. For high current pumps, use this wire to trigger a separate relay and use larger gauge wire to feed the pump - 10 gauge is recommended. The pump that include with TERMINATOR™ systems draws less than 10 Amps and can be powered directly by this wire. The fuel pump also requires a ground wire. Run a wire from the negative side of the fuel pump. Connect it to a solid chassis/frame ground.

Chassis Ground – Color = Black – Connect to a chassis ground point that has excellent connectivity with both the engine and battery. This ground should not be connected at the same location as other grounds.

"Tach Output" – Color = Blue with white stripe – This wire provides a 12v square wave output and can be used to trigger a conventional tachometer.

12.0 ADDITIONAL OUTPUTS

There are 3 optional outputs and one input available on the system that can be used for the following features:

- Air Conditioning Shutdown at wide open throttle
- Electric Fan #1 output
- Electric Fan #2 output
- IAC Kick input

These outputs are located in the "Input/Output" connector. This is an 8 Pin connector is located about 52 inches from the ECU. A mating harness is included with the system.

The following indicates proper wiring for these features.

A/C Shutdown – This output will provide a +12 volt output a defined throttle position. This output can be used to trigger a relay that deactivates the A/C at higher throttle positions. This may require the installation of a 5 pole relay in the existing A/C wiring. This wire is located in pin E of the 8 pin Input/Output connector and is Gray with a Yellow stripe.

Electric Fan #1 output – This output will provide a ground output to trigger a relay used for a cooling fan. This output should never be directly connected to a fan, but the relay that powers the fan. It should be connected to the ground trigger of the relay. This wire is located in pin G of the 8 pin Input/Output connector and is Gray with a Black stripe.

Electric Fan #2 output – This output will provide a ground output to trigger a relay used for a cooling fan. This output should never be directly connected to a fan, but the relay that powers the fan. It should be connected to the ground trigger of the relay. This wire is located in pin H of the 8 pin Input/Output connector and is Gray with a Green stripe.

IAC Kick input – This input will allow for the Idle Air Control motor to automatically make an increase in steps necessary to avoid a momentary drop in idle speed. This input is a positive +12v located in pin B of the 8 pin Input/Output connector and is White with a Red stripe.



Figure 33

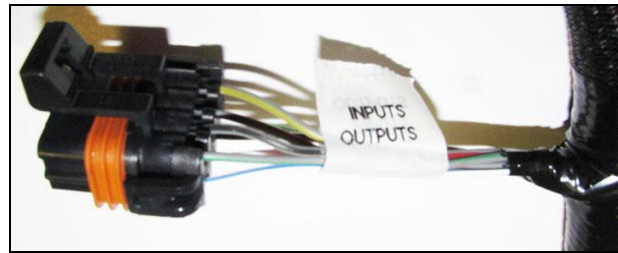

Figure 34

13.0 TRANSMISSION HARNESS

13.1 Transmission Wiring

The transmission harness can be used on 4L60E, 4L65E, 4L70E, 4L80E, and 4L85E transmissions. Each connector should be labeled.

Transmission ECU Connector (P4) – Plugs into the ECU. Plugs into the last connector opposite the main harness.

Main Transmission Connector – Simply plugs into the connector on the transmission. Located on the driver's side of a 4L80E (installed horizontally) and the passenger side on a 4L60E (installed vertically).

Vehicle Speed Sensor (VSS)/Transmission Output Speed Sensor (OSS) – Located on the rear drivers side on a 4L80E and the rear passengers side on a 4L60E

Turbine Speed Sensor – The 4L60E does not have a turbine speed sensor. It is located towards the front driver's side on a 4L80E. Note that a 4L70E has one internally wired, but is not connected to the Holley harness. The turbine speed sensor is not used for any calculations in the ECU, just for monitoring purposes.

Brake Switch (Grey) – Wired to the brake light switch. This must be installed to a +12v source (as most brake light switches are). This input is used to unlock the torque converter when the brakes are applied.

Ground (Black) – Connect to a good chassis/engine ground source

Power (Red) – Supplies power to the transmission solenoids. This should be connected to a +12v switched power source (must be capable of supplying 5 amps).

NOTE: The power supplying this wire must **NOT** be tied to the same point that the ECU switched power wire (red/white wire) is connected to. If they are tied together, the transmission power could back-feed power to the ECU and the ECU/engine will not shut off when the key is turned off. Use a relay or separate switched ignition power pickup point to supply power to the transmission harness.

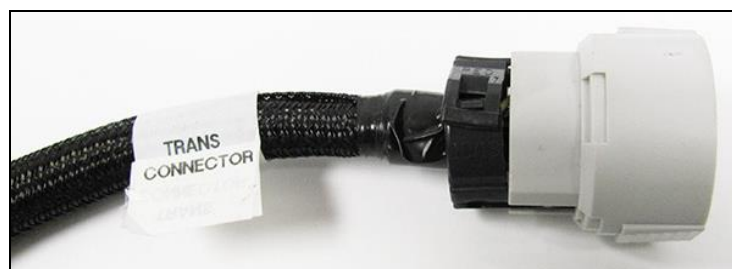

Figure 35 - Main Transmission Connector



Figure 36 - Vehicle Speed Sensor



Figure 37 - Turbine Speed Sensor

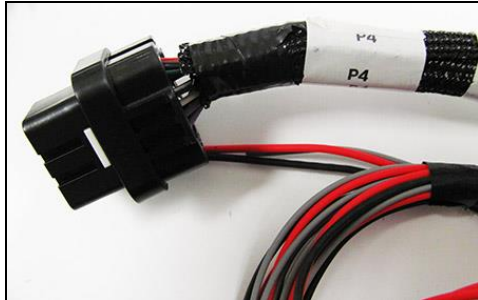

Figure 38 - Transmission ECU Connector

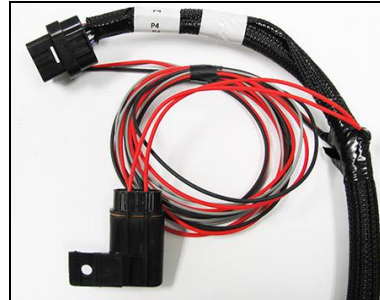

Figure 39 - Loose Wire Bundle

14.0 DRIVE-BY-WIRE HARNESS

14.1 Overview

The Holley Dominator ECU has built-in capability to control OEM type Drive-By-Wire throttle pedals and throttle bodies for aftermarket installation.

To ensure a safe and reliable installation, there are certain hardware requirements that **must** be followed:

See Appendix 3.0 for a listing of factory drive-by-wire throttle bodies and pedals that have been pre-calibrated and approved for use with this harness

14.2 Warnings!

Use only the drive-by-wire wiring harness supplied by Holley. THIS HARNESS CAN NOT BE CUT, SHORTENED, LENGTHENED, TAILORED, OR MODIFIED UNDER ANY CIRCUMSTANCE! THE HARNESS CONTAINS PROTECTIVE SHIELDING / GROUNDED CABLING TO ENSURE PROPER OPERATION. DO NOT REMOVE OR MODIFY THE PROTECTIVE SHEATHING UNDER ANY CIRCUMSTANCES. HOLLEY ASSUMES NO LIABILITY FOR ANY INSTANCES ARISING DUE TO USE OF THROTTLE PEDALS, THROTTLE BODIES OR ASSOCIATED COMPONENTS NOT SPECIFICALLY APPROVED BY HOLLEY.

14.3 Installation

Installation of both the drive-by-wire throttle body and pedal assembly should be performed by a professional, competent mechanic. It is important that the installation of both the throttle body and pedal assembly on an engine (not originally equipped with these components) be done in such a manner that assures proper operation of both components as intended by the OEM manufacturer.

- The throttle body must be installed in such a manner that the throttle plate(s) are allowed to rotate freely.
- The pedal assembly must also be installed in such a manner that it is rigidly and securely mounted, yet does not put the pedal in a bind, or put any mechanical stress on the electrical and electronic components. Proper positioning of the pedal is of the utmost importance.
- The accelerator pedal must have adequate clearance throughout the range of its travel to prevent the possibility of the pedal coming in contact with any item that may cause it not to return to the "idle" position upon release. The accelerator pedal must also be mounted far enough away from the brake pedal as to allow for the vehicle's brakes to be fully applied without the operator's foot coming in contact with the D-B-W pedal.
- The drive-by-wire pedal should be in a position such that it is lower than the brake pedal when the brake pedal is depressed.
- Installation of the wiring harness supplied by Holley must be done so that there is no chance the wiring may be cut or abraded. Rubber grommets should be utilized wherever the harness passes thru a firewall / sheet metal panel.
- The DBW harness should never be routed in such a manner that it may come in contact with "noisy" electrical components or wiring that may emit RFI and/or EMI noise. Typical "noisy" components and associated wiring in a vehicle would be spark plug wires, ignition coils, high energy ignition boxes, two-way radios (including CB's), etc. Maintain a minimum of 5" of clearance to any of these types of components.

The harness is designed to be "plug-and-play" with the throttle bodies and pedal assembly indicated above. It should not be used for any other applications.

14.4 System Safeties

Holley designed the drive-by-wire system to utilize a brake pedal switch input. This is wired to a +12v input from the brake pedal switch. If the brake pedal is depressed enough to activate the brake light switch, the following occurs:

- The ECU will not allow a pedal position over 10%, no matter how far the pedal is pushed. This consequently limits the opening of the throttle body.

Before a pedal value over 10% will be recognized, the following must occur in this order:

- Brake pedal switch must be released
- Pedal position must go below 10%

- Fuel flow is limited to 30 lb./hr. as an additional safety.

IMPORTANT! INSTALLATION OF THIS SAFETY CIRCUIT IS REQUIRED WHEN USING THE DRIVE-BY-WIRE FEATURE! DEFEATING OR NEGLECTING TO INSTALL THIS INPUT IS DONE SO AT THE USERS OWN RISK. THE USER ASSUMES ANY AND ALL LIABILITY FOR ANY DAMAGE, AS A RESULT OF A DRIVE-BY-WIRE MALFUNCTION.

Most drive-by-wire systems are designed so there are two position sensors on both the throttle body and the accelerator pedal assembly. This is done as a failsafe in the event that one of the position sensors should fail. Holley EFI systems require that both sets of sensors are functioning 100% properly. If any sensor moves from its calibrated position, the throttle body is immediately de-powered, forcing it to move to the factory “limp home” position. The “limp home” position is described in detail below. Whenever a fault is detected and the throttle body is de-powered, a fuel flow limit of 30 lb./hr. is also introduced.

14.5 Throttle Body “Limp Home” Position

Factory Drive-By-Wire Throttle Bodies have a “Limp Home” position. This is the position that the throttle body is at when no power is applied. It is typically enough air flow to allow a car to move at a speed of approximately 45 mph. This varies by manufacturer, but is the case with the GM throttle bodies this harness supports.

It should be strongly noted that this position allows MORE airflow than the engine uses for an idle position. If the throttle body goes into a “limp home” position due to a sensor failure or other reason, the engine will have more air and result in more power. This will require more brake pressure to be applied if a vehicle is in gear so that it does not move.

14.6 Drive-By-Wire DO’S and DON’TS

DO

- Use only the Holley supplied harness.
- Have the pedal, throttle body, and harness installed by a competent professional.

DON’T

- Do not use wire other than the Holley supplied harness.
- Do not cut, shorten, lengthen, or otherwise modify the drive-by-wire harness for any reason!
- Do not run drive-by-wire harness past high voltage or “noisy” sources
- Do not use this system if the pedal is not securely mounted as described in the instructions above. It must be SOLIDLY mounted with adequate room for safe and proper operation.
- Do not use this system if the throttle body is not properly mounted or has any potential of interference/binding of the throttle plates.
- Do not start the engine unless everything is operating properly.

14.7 Wiring

LS Engines came with two styles of connectors for their DBW throttle bodies; An 8 pin connector (early truck) and a 6 pin (passenger car and 2007+ truck) Appendix 3 contains more details and Holley supported part numbers for throttle bodies and throttle pedals and their associated harness part numbers.

ECU connector – plug into location J3 (See Section 10.1 – ECU pic)

Pedal Connector – plug into the throttle pedal

Throttle Body Connector – plug into the DBW throttle body.

Brake Switch Wire – This MUST be connected to a +12v input from the brake pedal switch.



Figure 40

APPENDIX 1.0 PINOUT

The following shows pins that are used on TERMINATOR™ systems. Pins that are not populated on TERMINATOR™ systems are denoted with an asterisk (*).

J1A Connector

Pin	Function
A1	Coil – Input
A2	Fuel Pump Relay Out (+12v) (10A Max)
A3	Input #2 (F,5,2,T,H,G)
A4	Input #4 (F,G,5)
A5	TPS Input
A6	Points Output
A7	WB1 COMPR2
A8	WB1 Shield
A9	WB HTR -
A10	Switched +12v Input
A11	Manifold Air Temp Input
A12	Input #1 (F,5,2,T,H,G)
A13	Input #3 (F,G,5)
A14	Cam/Crank Ground
A15	Gauge Output
A16	WB1 COMPR1
A17	WB1 VS-/IP+
A18	Sensor Ground
A19	Engine Coolant Temp Input
A20	Oil Pressure Input
A21	Knock Sensor #2 Input
A22	Cam Input / Bypass Out
A23	Map Sensor Input
A24	CAN Lo
A25	WB1 VS+
A26	Sensor +5v
A27	Bypass Out
A28	EST/Spout Output
A29	Knock Sensor #1 Input
A30	Crank Speed Input
A31	Fuel Pressure Input
A32	CAN Hi
A33	WB1 IP+
A34	WB HTR +

J1B Connector

Pin	Function
B1	IAC A Lo
B2	IAC A Hi
B3	PWM #4 Output (HG)
B4	Injector F (Cylinder 6)
B5	Injector G (Cylinder 7)
B6	Injector H (Cylinder 8)
B7	Injector E (Cylinder 5)
B8	IAC B Lo
B9	IAC B Hi
B10	PWM #3 Output (HG)
B11	PWM #2 Output (HG)
B12	PWM #1 Output (HG)
B13	Injector D (Cylinder 4)
B14	Ground
B15	EST B (Cylinder 2)
B16	EST D (Cylinder 4)
B17	EST F (Cylinder 6)
B18	EST H (Cylinder 8)
B19	Injector A (Cylinder 1)
B20	EST 12V Output
B21	EST A (Cylinder 1)
B22	EST C (Cylinder 3)
B23	EST E (Cylinder 5)
B24	EST G (Cylinder 7)
B25	Injector C (Cylinder 3)
B26	Injector B (Cylinder 2)

15.0 PREVIOUS INSTALLATION REQUIRED

At this point, the installation of your EFI system should be 100 percent complete. The ECU, TERMINATOR™ Handheld controller, throttle body and intake hardware, all sensors, wiring, fuel pump, regulator and return line, and all other hardware should be installed. The vehicle should be ready to start and run. If this is not the case, refer to the hardware installation manual included with your particular system.

16.0 TERMINATOR™ INSTRUCTIONS AND TUNING

The TERMINATOR™ EFI systems are designed to be easy to use for the first time EFI tuner. The instructions are set up in that manner as well. These instructions will not get into detail about EFI theory and operation. They will provide the steps necessary to get you up and running quickly. The TERMINATOR™ system allows for the user to perform some basic changes to the tuning *if they desire to do so*. The instructions are sequenced to get you up and running so you can enjoy your vehicle, then review some of the parameters that can be adjusted to fine tune your vehicle at a later time if desired.

17.0 INITIAL POWER-UP

Turn the ignition key to the “run” position. This should apply power to the ECU as well as the TERMINATOR™ Handheld control module. The handheld should power up and the Home Screen (**Figure 41**) should appear.

The Home screen contains icons which will navigate to different functional features of the 3.5 Touch Screen. These features will be discussed in detail throughout this manual.



Figure 41 – Home Screen

NOTE: DO NOT ATTEMPT TO START THE VEHICLE UNTIL YOU ARE TOLD TO DO SO IN THE INSTRUCTIONS BELOW.

NOTE: The handheld has a SD memory card installed in the side. This card contains specific information that is required for the use of the TERMINATOR™ product. DO NOT replace this card with another. There should be no need to remove this card for normal use.

18.0 HANDHELD NAVIGATION & USE

The 3.5" handheld utilizes a touch screen display. All navigation is done through "touching" an icon or button on the screen. The following is an overview of the different types of adjustment screens that are used in the display, and that may be utilized when tuning or making selections.

18.1 Making Adjustments

Slider Bar: Slide the bar left or right with the stylus, or use the right and left arrow keys for fine adjustment (Figure 42).

List: Use the scroll bar on the right hand side of the screen to view all list entries. Touch the desired list item and click 'OK' to make a selection (Figure 43).

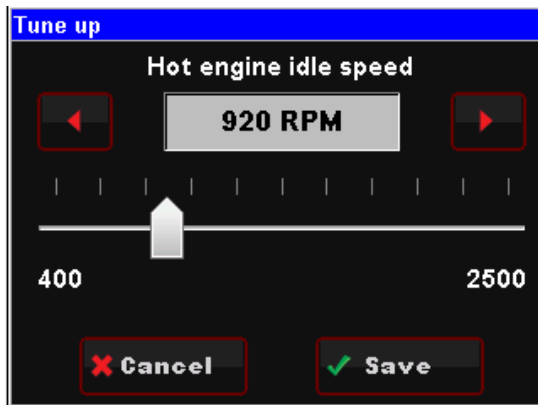

Figure 42 – Slider Bar

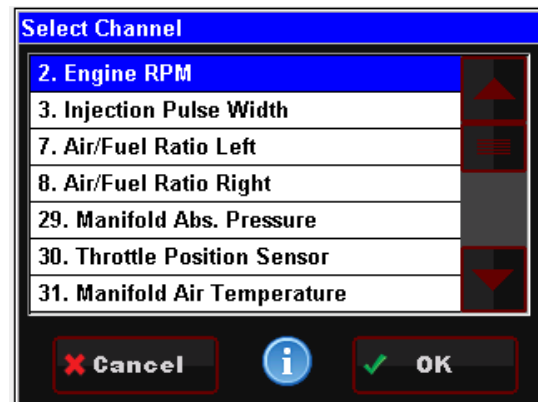

Figure 43 – List

Radio Button: Touch the desired list item to select it (Figure 44).

On Screen Prompts: Follow the on screen text and use buttons at the bottom of the screen to continue or confirm (Figure 45).



Figure 44 – Radio Button



Figure 45 – On Screen Prompts

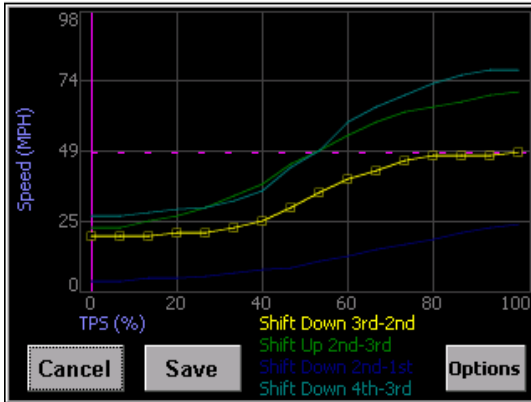

Figure 46 – Graph

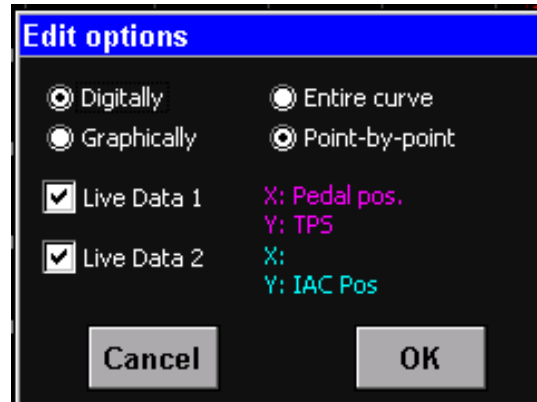

Figure 47 – Edit Options

Digitally: Selecting this option enables slider bar adjustment of individual data points on the graph or the entire curve.

Graphically: Selecting this option enables single point or whole curve adjustment. A stylus may be used to select and drag data on the graph screen.

Entire Curve: Selecting this will 'lock' all the data points together allowing the entire curve to be shifted up or down

Point by Point: Selecting this will allow point by point curve adjustment for fine tuning.

Live Data 1 & 2: This will enable live telemetry on the graph screen making fine tuning easier.

19.0 HOME SCREEN

The HOME SCREEN has 4 selections (**Figure 48**). They are explained in more detail later in the instructions.

TUNING – Allows for various parameters to be easily adjusted.

MONITOR – A variety of gauge and dash displays.

FILE – Saves and loads files. Also shows information about the ECU and handheld controller.

WIZARDS – Creates a base calibration and performs the "TPS Autoset" function.



Figure 48

20.0 CALIBRATION WIZARD

The first step is to create an initial calibration using the WIZARDS located on the HOME SCREEN.

1. Select WIZARDS
2. Select START GCF WIZARD (**Figure 49**)
3. The Wizard process will guide you through each selection step. There will be a question at the top. Select the proper response and select "Next" at the bottom. Selecting "Home" at any time will cancel the process.
4. Next, select "Holley MPFI" for the system type. (**Figure 50**).
5. Next, select "Terminator LSx" for MPFI System Type (**Figure 51**).
6. Next, select "24x" or "58x" depending on your crankshaft sensor type. The kit that was purchased would have been based on the crankshaft sensor type (**Figure 52**).

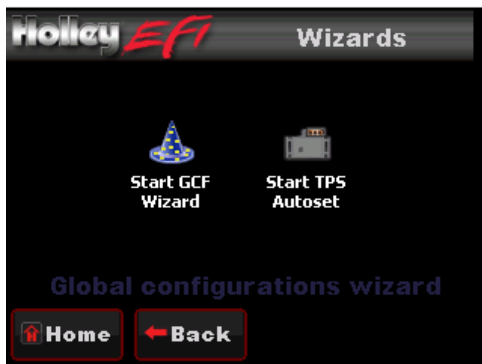

Figure 49



Figure 50



Figure 51



Figure 52

7. Next, select whether you have GM Drive-By-Wire. In not, select "No". If so, select "Yes" (**Figure 53**).
8. Next, select whether you have an electronic transmission or not. In not, select "None". If so, select whether it is a 4L60 or 4L80 (**Figure 54**).
9. Next, select whether the cam is stock or not. If it's stock, select "Stock". If it's not, select "Mild" (**Figure 55**). The "Mild" selection should work well for most "street performance" camshafts. If a camshaft is more race oriented, laptop tuning may be required.
10. Next, select the displacement of the engine. If it is a 4.8L, or 5.3L engine, select "4.8 or 5.3". If it is a 5.7L engine, select "5.7". If it is a 6.0L engine, select "6.0". If it is a 6.2L engine, select "6.2" (**Figure 56**).
11. Next, select the Injector group that contains the specific injector part number being used (**Figure 57**). Refer to Appendix 1.0 for a list of supported injector part numbers and their groupings.



Figure 53



Figure 54



Figure 55



Figure 56



Figure 57

- After selecting injector type, your calibration will be created (Figure 58). Press the “Upload” button to send the calibration to the ECU. You will then see a screen showing “Uploading” (Figure 59). Finally you will see a screen indicating the file is uploaded. Cycle the ignition switch for the calibration to take affect (Figure 60). Proceed to section 21.0.

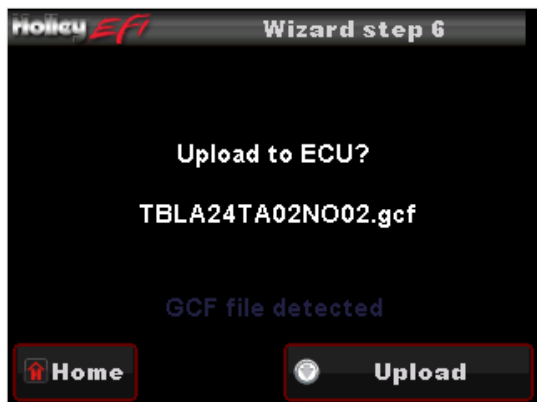

Figure 58

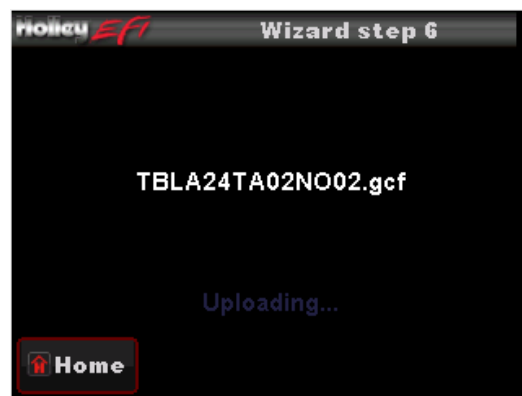

Figure 59



Figure 60

21.0 TPS AUTOSSET

The next step is to perform a “TPS Autoset”. This must be done with the vehicle ignition power on. **This must be done on a brand new system otherwise the injectors and ignition will not be fired by the ECU.** A TPS Autoset programs the ECU with the full travel/voltage range from idle to wide open throttle for the Throttle Position Sensor (TPS). The TPS Autoset function is found under the “WIZARDS” choice under the HOME SCREEN. Select “START TPS AUTOSSET”. Follow the prompts. You can select “Home” at any point to stop the process. If everything is successful, you will see a TPS Autoset Successful message.



Step 1: Select TPS Autoset



Step 2



Step 3



Step 4: Select 'Done'

22.0 TRANSMISSION SETUP

At this time, if an electronic transmission is being used, basis drivetrain parameters need to be set up.

22.1 Transmission

Selecting TRANSMISSION brings up the following menu. There are two areas you can modify; TRANS SETUP and SPEED CALC. These are reviewed below (Figure 61).

22.1.1 Trans Setup

Transmission RPM: If this RPM is exceeded when in manual shift mode, the transmission will upshift automatically. If a manual downshift is performed, and this RPM will be exceeded, the downshift will not be allowed. This value should be slightly higher than the WOT shift points (Figure 62).

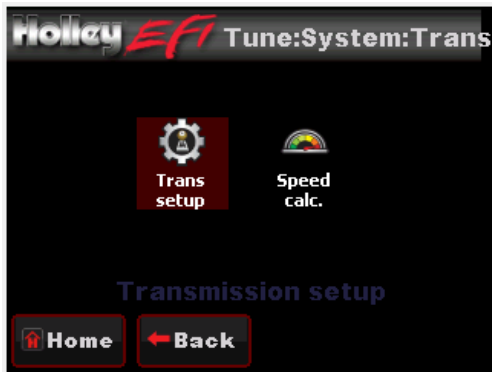

Figure 61

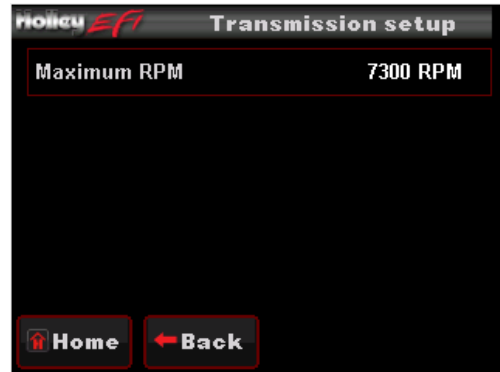

Figure 62

22.1.2 Speed Calc

Four pieces of information will need to be entered via the 3.5 handheld to attain proper speedometer calibration when using Holley transmission control

- **Tire Diameter** – From 10.0 to 70.0 inches (Example 26.4)
- **Rear Gear Ratio** – From 0.50 to 9.99 (Example 3.73)
- **Speedometer Output** – Enabled or Disabled, provides an output to an electronic speedometer.
- **Pulses Per Mile (PPM)** – Pulses produced per mile

Note: The terminator harness does not have a Speedometer output wire, nor is the calibration programmed for it.

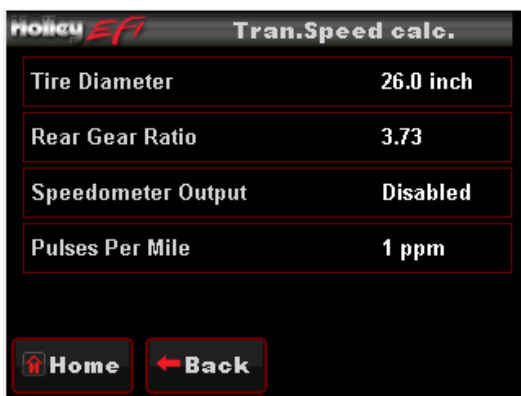

Figure 63

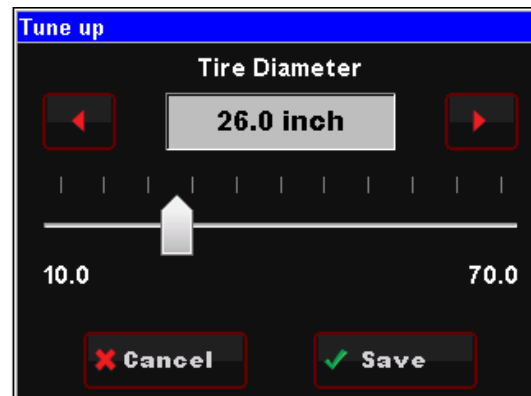

Figure 64

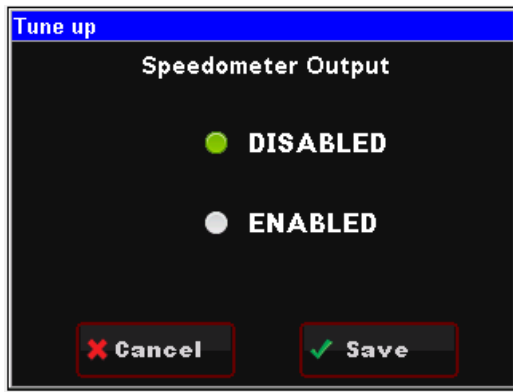

Figure 65

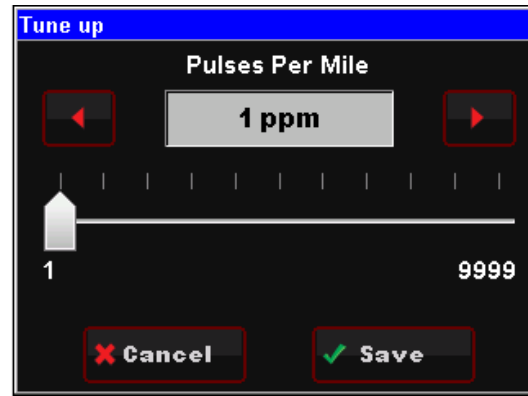

Figure 66

23.0 SENSOR VERIFICATION

Before starting the vehicle, verify that all of the sensors are reading properly. At this time, turn the key off, and cycle it back on. At this time you should hear the fuel pump come on and run for 5 seconds. Check for fuel leaks at this time as well.

On the HOME SCREEN, select the MONITOR tab. This will bring up various options. Select the “Monitors” screen. You will see a screen called “Sensors”. Select this. With the key on and the engine off, these sensors should read as follows:

- **MAP** (Manifold Air Pressure Sensor) – Should read from 95-102. At high elevations it could read as low as 75.
- **TPS** (Throttle Position Sensor) – Slowly depress the throttle to wide open. It should read 100 at wide open throttle. Cable operated throttle bodies should read 0 closed.
- **MAT** (Manifold Air Temperature Sensor) – reads current air temperature
- **CTS** (Coolant Temperature Sensor) – reads engine temperature. If the engine is “cold”, it should read almost the same as the MAT sensor.
- **Battery** – Will read battery voltage. Should be 12.0 volts minimum.

If ANY of these sensors are not reading properly, this must be resolved before the engine is started.

24.0 STARTUP

The vehicle should be ready to be started. Open the same sensors screen as in section 23.0. Make sure the TPS is reading 0. If it does not, do a TPS AUTOSET, or if it is reading 1-2%, close the idle screw on the throttle body slightly.

Crank the engine and look at the RPM parameter. It should change to “Syncng”, indicating the ECU is syncing with the RPM signal for an instant, then show an RPM signal. The engine should fire and run and come to an idle.

If you do not get an RPM signal, there is an error in the wiring or system setup. Call Holley Tech service for advice.

If the engine starts but is idling too low and appears to be struggling for air, refer to section 26.0 for cable operated throttle bodies and section 31.6 for drive-by-wire.

25.0 AFTER-STARTUP

Once the vehicle has started, look for any fuel or coolant leaks. Let the vehicle warm up and look at some other parameters to make everything is operating properly. Go into the MONITOR, MONITORS, and select the “Closed Loop” icon.

- **Closed Loop Status** – Indicates whether the engine is “Closed Loop” or “Open Loop”. Closed Loop indicates that the ECU is adding or subtracting fuel to maintain the target air/fuel ratio. The TERMINATOR™ calibrations are such that the system should be operating closed loop almost all of the time.
- **Closed Loop Compensation** – This is the percentage of fuel that the ECU is adding or subtracting to maintain the target air/fuel ratio at any specific moment. A value with a minus (-) sign in front indicates the ECU is removing fuel. A value with no minus sign indicates the ECU is adding fuel. When in open loop operation, this will always stay at 0%.
- **Target Air/Fuel Ratio** – This is the target AFR (air/fuel ratio) the ECU is trying to maintain. This will vary depending on the engine speed and load.

- **Air/Fuel Ratio Left** – This will show the air/fuel ratio the wideband oxygen sensor is reading. The Closed Loop Compensation should be adding or subtracting fuel all the time such that the AFR Left should always be close to the Target AFR value. (Note ARF Right will only be active if a second sensor is being used which is not included).
- **Fuel Learn Status** – This indicates the status of the TERMINATOR™ “Self Tuning” operation (Learn Status). The system will automatically tune itself as you drive around. There are several conditions that must occur in order for the Self Tuning to occur. The engine temperature must exceed 160° F. The system must be operating in a closed loop mode, and the Self Tuning must be enabled. The base TERMINATOR™ setups have the Self Tuning enabled. Once the engine reaches 160° F, the Self Tuning should be active. The Learn Stat will show “NoLearn” when Self Tuning is not active and “Learn” if Self-tuning is active.

If any of these parameters are not showing a proper value, find out why before further driving the vehicle.

26.0 IDLE SETTING/CABLE OPERATED THROTTLE PLATE SETTING

Once the engine is up to operating temperature, the idle speed can be set to what is desired.

From the HOME SCREEN, select the TUNING tab. Then select the BASIC and then BASIC IDLE. You can see what the target hot idle speed is set to. If you are happy with the current value, use the BACK or HOME button to exit. If you would like to change it, click on the IDLE SPEED. This brings up a screen to adjust the idle speed (**Figure 67**). Move the button left and right to adjust it. Click the button to save the new value or select CANCEL at the bottom to move out of this screen.

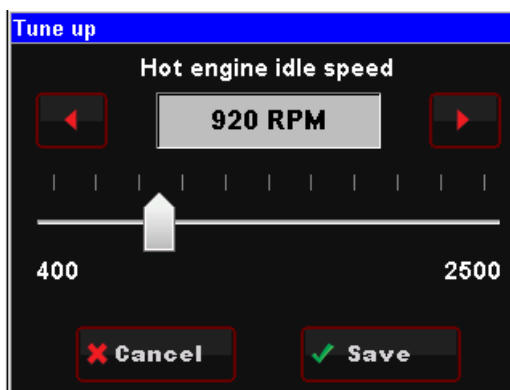

Figure 67

Whether you change the target idle or not, you need to set the throttle plates on the throttle body to an optimal position. To do so, with the engine running select the MONITOR tab. You will see the IDLE screen. Look at the “IAC Position” value. This value should be set between 2 and 10 with the engine in neutral and up to operating temperature. Also make sure the “TPS” value is showing a value of 0. If it is not, you need to perform a TPS AUTOSET.

If the “IAC Position” value is showing zero, you must close the throttle plates until it reads a value of 2-10. Slowly turn the throttle shaft adjustment screw on the throttle body out (counter-clockwise). If the IAC position is “stuck” at 0, it is likely that the engine is idling at a higher speed than you have set the target idle speed for. You need to adjust the throttle plates to resolve this issue.

If the “IAC Position” value is greater than 10, it is a good idea to open (turn the throttle shaft adjustment screw in, clockwise) the throttle plates until the “IAC Position” value is between 2 and 10. Note that if you open the throttle plates such that the “TPS” position goes above a value of 0, you will need to shut the vehicle off and perform a TPS AUTOSET. Then restart the vehicle and continue adjusting the throttle plates. Once the TPS goes above a value of 0, the ECU goes out of its “idle” mode and will lock the IAC Position to a fixed value.

When the adjustments are completed, make sure the TPS reads a value of 0 with the engine idling.

27.0 SELF-TUNING

At this point, it is time to just drive the vehicle and let the system perform its self-tuning process. The best way for this is to drive the vehicle under as many different operating conditions as possible. Different engine speeds and loads. Start by slowly revving the engine up in neutral and holding it at different speeds up to 2500 RPM. This will help the system learn these points. Then drive the vehicle, possibly using different transmission gears to learn in different areas. If you have an automatic transmission you may want to put it in gear, and with your foot on the brake pedal, apply a SMALL amount of throttle so that the system learns in this area as well.

NOTE: There are several conditions where Learning will NOT occur. They are the following:

- If the engine is below 160° F
- When the engine sees quick accelerator pedal movement
- Certain times when the accelerator pedal is lifted and the vehicle is coasting
- If the learn is disabled by the user

If you are interested in seeing if Self Tuning is completed in a certain area, you can look at the following:

- Select MONITORS from the HOME SCREEN
- Select the LEARN icon
- The FUEL LEARN STATUS indicates if the learn feature is active. The FUEL LEARN PERCENT indicates what the learn value is.
- Look at the CLOSED LOOP COMPENSATION value. Once this value is close to zero, learning is complete in an area.

At this point you can drive and enjoy your TERMINATOR™ EFI as it is. Sections 25.0 – 30.0 describe how you can adjust various parameters to further optimize fuel economy and overall performance, if desired.

28.0 GAUGE SCREENS

The display has a nice variety of pre-configured gauge screens and also allows the customization of them as well. There are also user-programmable caution and warning limits. The following reviews these areas.

28.1 Monitor

Choose MONITOR from the HOME screen to access live telemetry and customizable gauge screen options.



Figure 68

28.1.1 Multi-Gauge

- **Sensors:** Manifold Absolute Pressure (MAP), Coolant Temperature (CTS), Throttle Position (TPS), AFR Left, Engine RPM (analog), Battery Voltage, Ignition Timing, Manifold Air Temperature (MAT), Fuel Pressure, Engine RPM (digital), and Fuel Injector Duty Cycle.
- **Air/Fuel Ratio:** AFR Left, Target AFR, AFR Right, Closed Loop Compensation, Fuel Learn, Closed Loop Status, Engine RPM (analog), Learn Status, Fuel Injector Pulse Width, Engine RPM (digital), and Oil Pressure.
- **Outputs:** Fan #1, Fan#2, AC Shutdown, CTS, Engine RPM (analog), IAC Position, AFR Left, Battery Voltage, Fuel Pressure, Engine RPM (digital), Oil Pressure.
- **Drive-By-Wire:** TPS, Pedal Position, TB Position, TB TPS #1, Engine RPM (analog), Pedal TPS1, TB TPS #2, Pedal TPS2, Brake Pedal, Engine RPM (digital), MAP.
- **Transmission:** Gear, Engine RPM (digital), Line Pressure, TCC Duty, Engine RPM (analog), TCC Lockup, Line Temp, Input Shaft Speed, TPS, Speed, Fuel Economy.
- **Dash 1, 2, & 3:** See the 'Dash Setup' section 26.1.

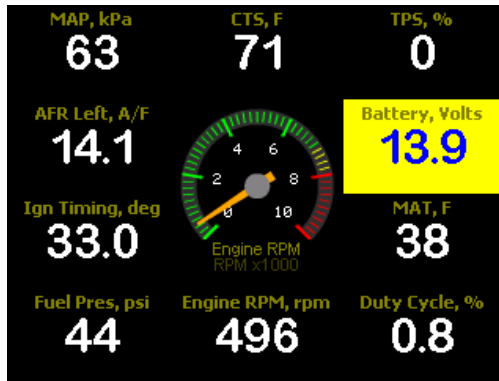

Figure 69 – Sample of Multi-Gauge Screen

28.1.2 Monitors

- **Idle:** Engine RPM, TPS, IAC Position, AFR Left, Ignition Timing
- **Learn:** Fuel Learn Status, Fuel Learn Percent, Closed Loop Compensation, Target AFR, AFR Left
- **Closed Loop:** Closed Loop Status, Closed Loop Compensation, Target AFR, AFR Left, Fuel Learn Status
- **Sensors:** MAP, TPS, MAT, CTS, Battery Voltage
- **Fuel:** Engine RPM, AFR Left, Injector Pulse Width, CL Comp, Injector Duty Cycle
- **Misc:** Oil Pressure, Fuel Pressure, Fan #1 Status, Fan #2 Status, AC Shutdown Status
- **Drive-By-Wire:** Gas Pedal Position, TB TPS #1, TB TPS #2, Pedal TPS #1, Pedal TPS #2, TB Position, Brake Pedal Position
- **Transmission:** Gear, Speed, Line Pressure, Line Temperature, TCC Duty Cycle, TCC Lockup Status, Input Shaft Speed

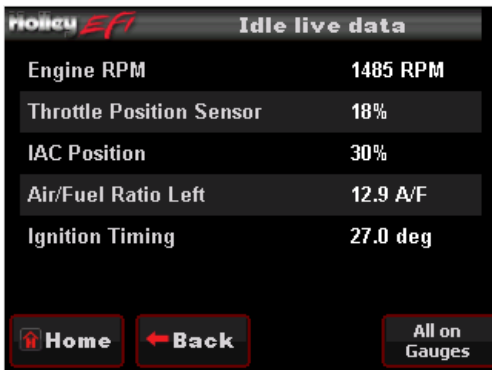

Figure 70

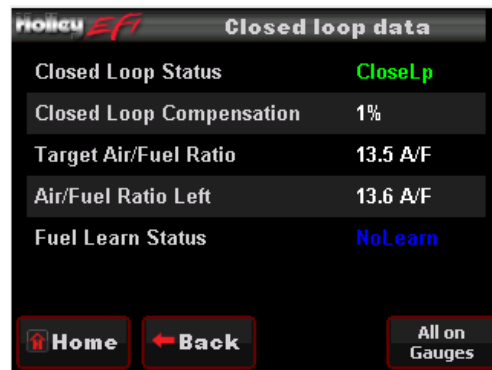

Figure 71

Samples of Monitor Screens

28.1.3 Diagnostics

Channels displayed are: AFR Left, AFR Right, MAP, TPS, MAT, CTS

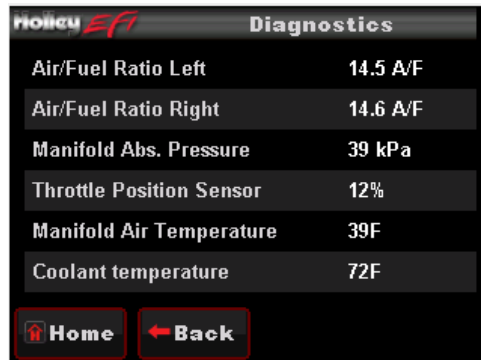

Figure 72 – Sample Diagnostics Screen

29.0 Custom Setups

29.1 Dash Setup

Up to three (3) Custom gauge layouts can be created on the 3.5 Touch Screen. Follow these steps to configure:

Step 1: Choose 'Dash Setup' from the Multi-Gauge screen (Figure 73).

Step 2: Choose the Dash number to be configured (Figure 74).



Figure 73



Figure 74

29.2 Channels Scaling

Each HEFI channel displayed by the 3.5 Touch Screen can be configured to have caution and warning indicators. To do this, choose 'Channel Scaling' from the MONITOR menu. Cautions will display as Yellow and Warnings will display as RED when using the Multi-Gauge screens.

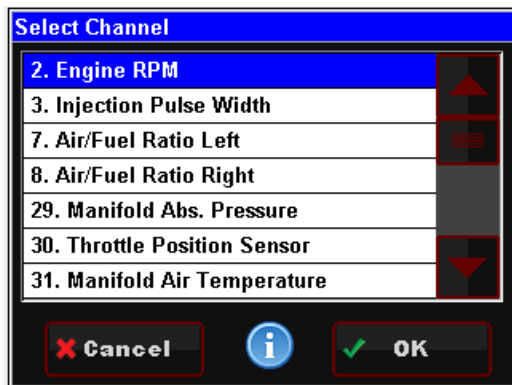

Figure 75

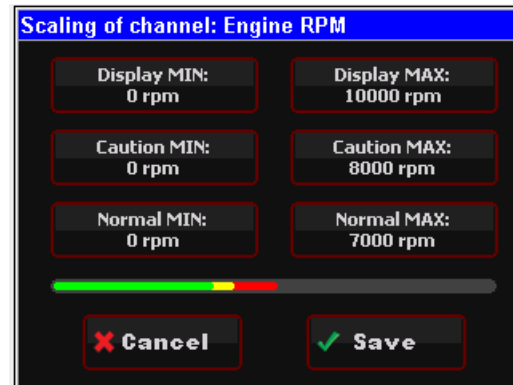

Figure 76

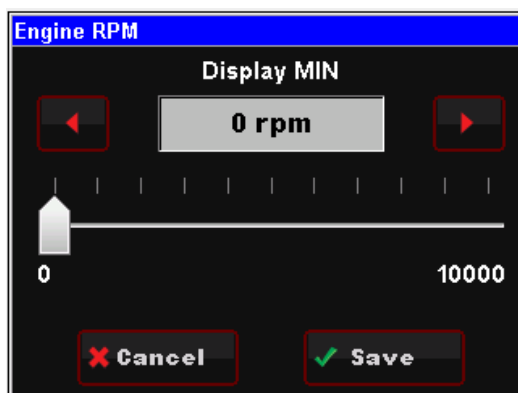

Figure 77

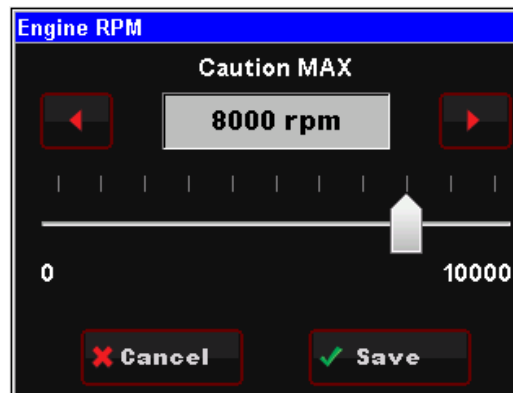

Figure 78

30.0 FILE SAVING/LOADING

The following areas review the options located under the FILE selection. Access to any of these areas should not be necessary for normal use of your Terminator system.

30.1 File

Choose FILE from the HOME screen to access ECU and 3.5 touch screen information. This is also where ECU logging and Global Folder (calibration file) transfer menus are located.

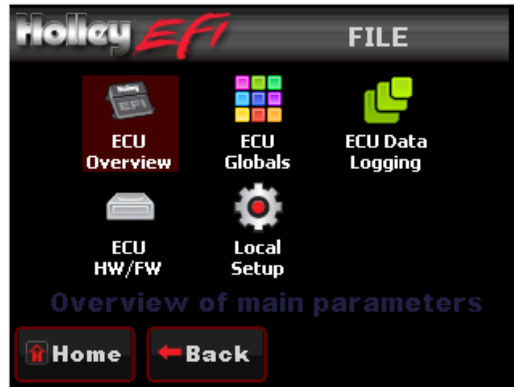

Figure 79

30.1.1 ECU Overview

Information specific to the engine and ECU configuration is shown here, these include the name of the current global folder, transmission type, ignition input type, WBO2 type, throttle body type, fuel system type, and ECU firmware version. Note that this menu is view only – no information can be changed. Any changes to engine or transmission setup must be done through the TUNING or WIZARDS menu.

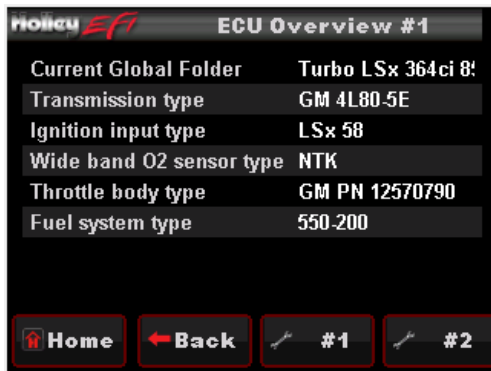

Figure 80



Figure 81

30.1.2 ECU Globals

This menu will list any global folders that have been saved to the SD card. It will also allow you to download a global folder from the ECU to the SD card so that it may be opened on any Windows based PC with free Holley EFI software installed. Software may be downloaded at <http://www.holley.com/data/TechService/Technical/Holley%20EFI%202.2.0.3%20Setup.zip>

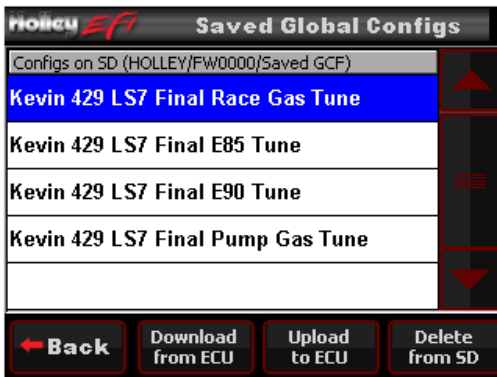

Figure 82 - Global Folders List

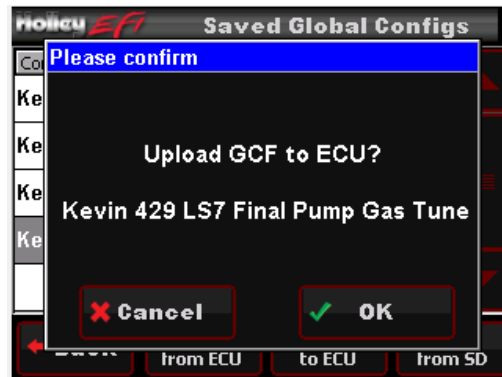

Figure 83 - Global Folder Upload to ECU from SD Card

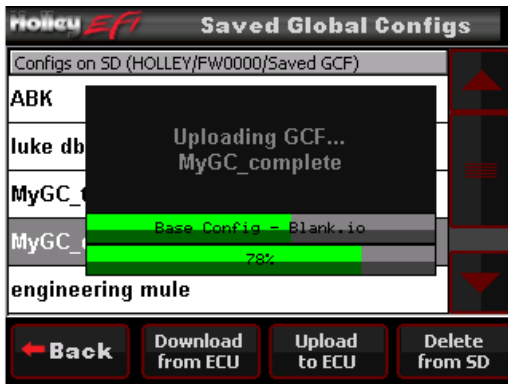

Figure 84 - Upload Status Screen

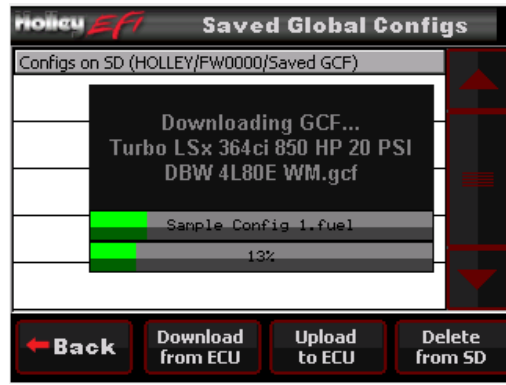

Figure 85 - Global Folder Download to SD Card Status Screen

30.1.3 ECU Data Logging

LS Terminator MPFI systems come standard with powerful data logging capabilities. Logging can be stopped and started via the 3.5 Handheld. The sampling rate is adjustable from 1 to 100 samples per second and can be changed by selecting 'Setup'. Typically a high sampling rate is used for drag racing and a lower rate may be used for something such as road racing. Choosing 'Files' in the DATA LOGGING menu will display all logs contained within the ECU's memory, from here any file may be saved to the SD card and viewed through the Holley EFI PC software.

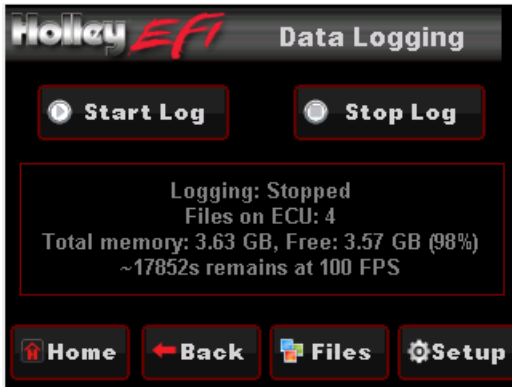

Figure 86

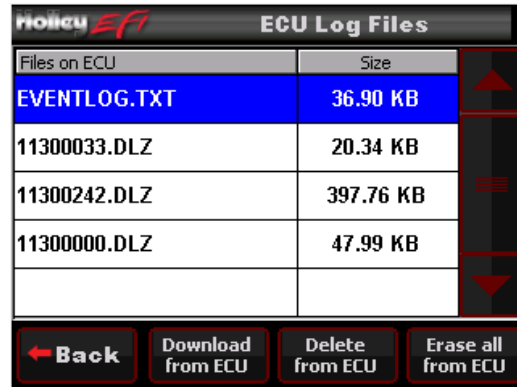

Figure 87

30.1.4 ECU Hardware/Firmware (HW/FW)

Use this menu to update ECU Firmware. Also includes ECU data including serial number, date code, firmware version, and profile number.



Figure 88

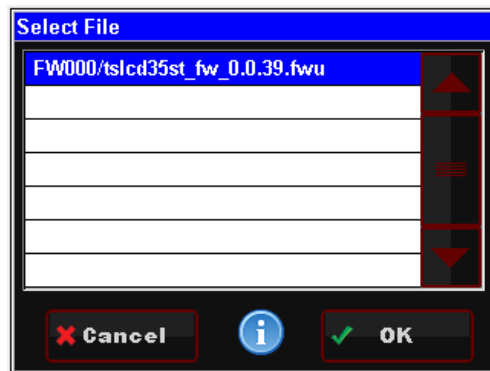

Figure 89

30.1.5 Local Setup

Contains calibration options for the 3.5 Handheld: Touch Calibrate, Local Info, & Local Options.

30.1.5A Touch Calibrate

The touch screen may be recalibrated by following the on screen prompts (Figure 90).

30.1.5B Local Info

Displays device and firmware information for the 3.5 Handheld (Figure 91).

30.1.5C Local Options

By selecting 'Restore screens on startup' the 3.5 Handheld will revert to the last screen used prior to powering off (Figure 92).

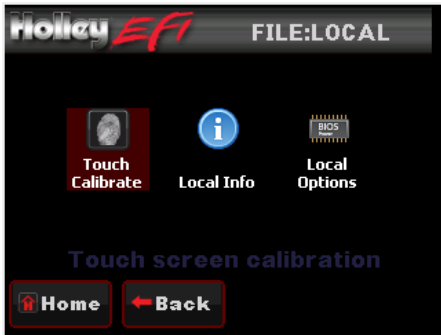

Figure 90

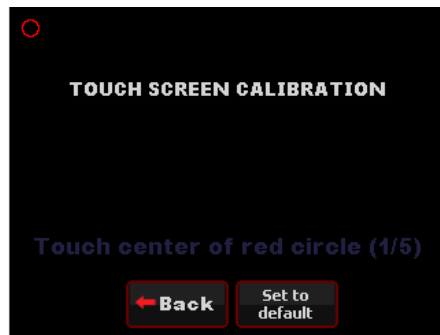

Figure 91



Figure 92

31.0 BASIC TUNING

The TERMINATOR™ systems allow the user to perform some basic tuning changes to help optimize mileage, drivability, and performance. The tuning is split up into “Basic Tuning” and “Advanced Tuning”. The Basic Tuning allows changes to the Air/Fuel Ratio’s the engine runs at and changes to Ignition Timing if a GM HEI or Ford TFI is used. The Advanced Tuning is typically not needed, but allows changes to some items that are less commonly used, or require some careful understanding before changing.

From the HOME SCREEN, select TUNING, and BASIC. There are six areas you can modify, BASIC FUEL, FUEL LEARN, BASIC IDLE, SPARK, DRIVE-BY-WIRE, and TRANSMISSION (with Drive-By-Wire and Transmission applying if applicable). These are reviewed below (Figure 93).

31.1 Basic Fuel

Selecting BASIC FUEL (Figure 94) brings up the following menu:

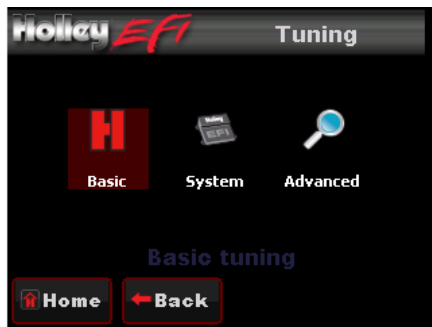

Figure 93



Figure 94

31.1.1 Target AFR

Allows changes to the Target Air/Fuel ratio at idle, cruise, and wide open throttle. The following are typical values and some tuning notes.

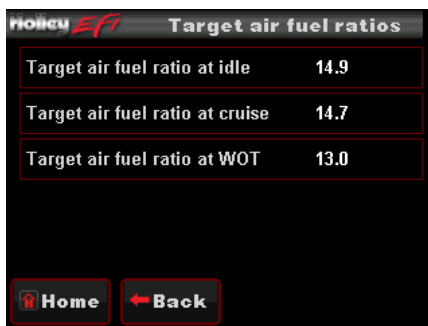

Figure 95

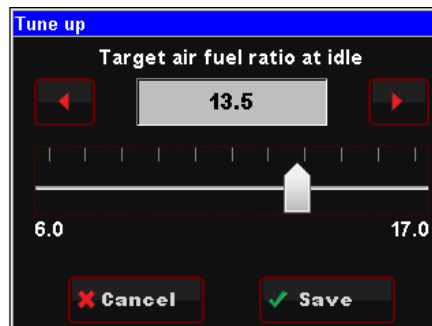

Figure 96

- **Idle Air/Fuel Ratio** – Typically between 13.5 and 15.0. Engines with larger cams may need a richer setting for smoothest idle.
- **Cruise Air/Fuel Ratio** – Typically between 13.5 and 15.5. Engines with larger cams may need a richer setting for smoothest operation.
- **Wide Open Throttle Air/Fuel Ratio (WOT)** – Typically between 12.0 and 13.0. Running richer may reduce power. Running leaner may reduce power or cause potential engine damage.

NOTE: The Target Air/Fuel setting between IDLE, CRUISE, and WOT is blended together automatically. Consequently, the air/fuel you see on the MONITOR screen, may not be exactly what you set for the settings. Changing these settings raises or lowers the “curve” of that specific area.

31.1.2 Acceleration Enrichment

Changes the “accelerator pump” function of the fuel injection. Raising the number increases the amount of fuel added when the pedal is pushed. Lowering the number decreases the amount of fuel added when the pedal is pushed. It is highly recommended NOT to change this until the ECU is allowed to perform self-tuning.



Figure 97

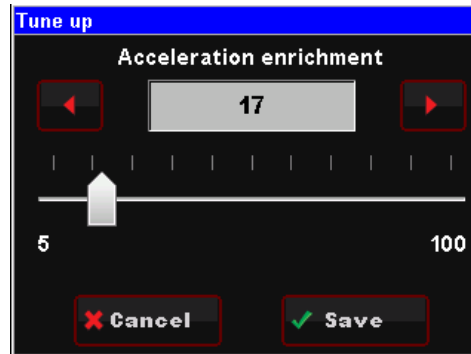

Figure 98

31.1.3 Fuel Prime

Fuel prime is an option that is enabled by default in all of the base calibrations. The fuel prime function injects a small shot of fuel into the intake manifold when the ignition is turned on, wetting the intake and allowing the engine to start much quicker. The amount of fuel is based on the engine temperature and how long it was since the engine previously ran. This amount of fuel can be increased or decreased by changing the “Percent” value. If the engine seems flooded reduce this value, if the engine seems to want more fuel, increase it. Experiment for best results. Typically this value will range from 75-150% with a maximum of 200% typically used.

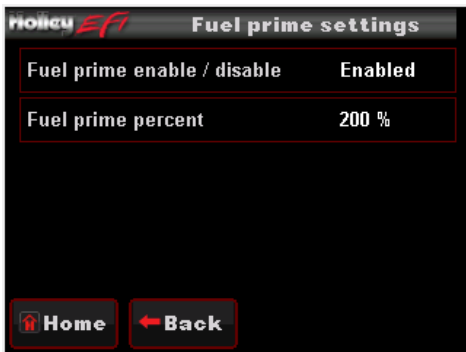

Figure 99

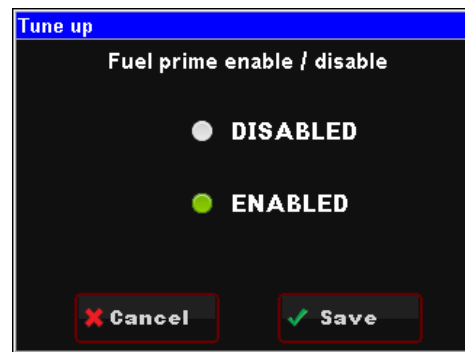

Figure 100

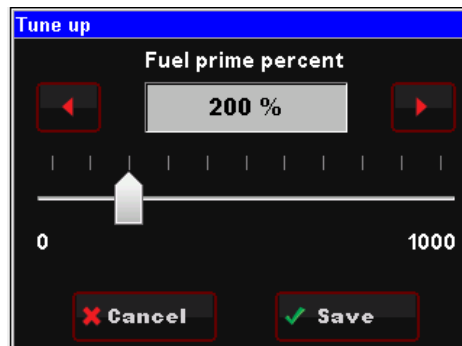

Figure 101

NOTE: This only injects fuel once at key-on, and will not do it again until the engine has run. This fuel prime occurs ½ of a second after key-on. If you quickly turn the ignition key without waiting for ½ a second, the prime will not occur and it may take longer for the engine to start.

31.2 Fuel Learn

31.2.1 Learn Enable/Disable

The LEARN Enable / Disable menu turns the Self Tuning “On” and “Off”. If enabled, self-tuning is performed. Learning should be enabled when an engine is just started and the tuning process is occurring. After the vehicle is driven under various operating conditions, and is running well, it is advised to disable learning, OR slow the Learn Speed to “Slow”.

31.2.2 Learn Speed

This parameter adjusts how fast the learning process occurs. In the beginning with a new tune it should be set to “Fast”. After the vehicle is driven under various operating conditions, and is running well, it is advised to disable learning, OR slow the Learn Speed to “Slow”.

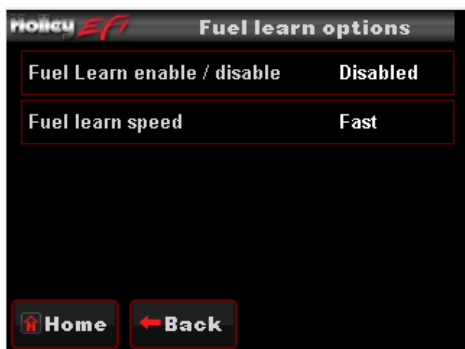

Figure 102

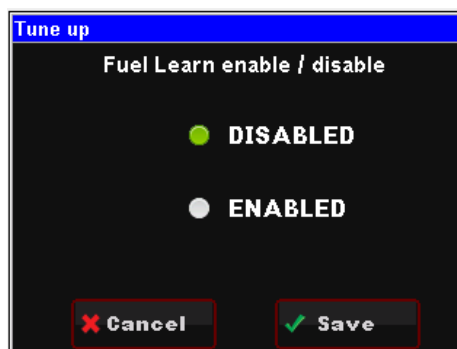

Figure 103

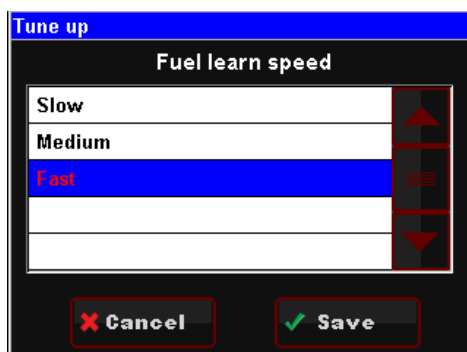

Figure 104

31.3 Basic Idle

Selecting BASIC IDLE allows you to change the Target Hot Engine Idle Speed. This should be adjusted to your desired idle RPM. Values between 650-800 rpm are typical. Larger camshafts or aftermarket torque converters may require a slightly higher value to maintain proper idle quality while in gear.

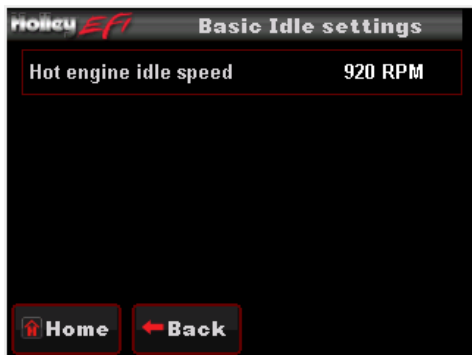

Figure 105

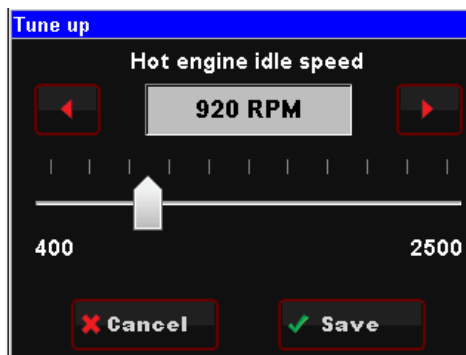

Figure 106

Selecting IDLE allows you to change the Target Idle Speed (**Figure 105**).

IDLE SPEED: Adjust the idle speed to what is desired. See section 23.0 on re-adjusting idle speed.

31.4 Spark



Figure 107

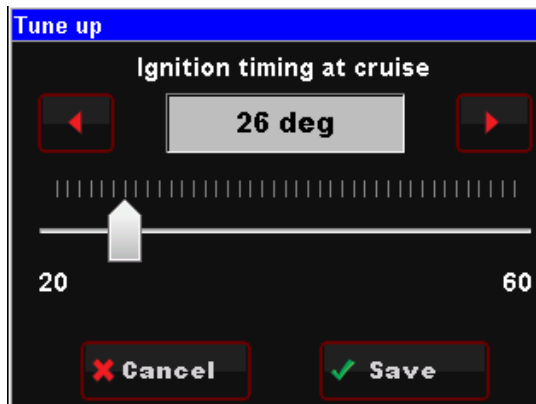

Figure 108

All Holley base tunes contain timing curves that will provide adequate engine operation, however the ignition timing at idle, cruise, and wide open throttle can be adjusted independently from each other to compensate for different engine combinations and geographical and climate extremes.

The following are typical values for each:

- **Idle Timing** – 18-34 degrees is typically used at idle. The larger the camshaft, the more timing is usually used.
- **Cruise Timing** – 32-48 degrees is typically used when cruising for optimal fuel economy.
- **Wide Open Throttle Timing (WOT)** – LSx applications typically don't use more than 28 degrees at WOT. Older V8 engines are usually between 32-38 degrees.

NOTE: Too much timing can cause pre-ignition that can damage an engine. Be cautious when tuning.

NOTE: The actual timing between IDLE, CRUISE, and WOT is blended together automatically. Consequently, the timing you see on the MONITOR screen, may not be exactly what you set for these settings. Changing these settings raises or lowers the "curve" of that specific area.

31.5 Transmission

NOTE: Caution must be used when modifying transmission parameters. Lowering Line Pressures too much can cause rapid wear and damage to the transmission. The base calibrations provided should provide a safe base calibration. If the transmission has very soft shifts or seems to slip, immediately stop to diagnose whether the problem is due to tuning or mechanical issues.

Selecting TRANSMISSION brings up the following menu. There are five areas you can modify; SHIFTS, WOT SHIFTS, TCC PARAMS, TCC (UN)LOCK, and LINE PRESSURE. These are reviewed below.

31.5.1 Shifts

Each Up-shift and Down-shift can be completely configured by selecting 'Shifts' from the transmission menu. Refer to section 18.1 (Making Adjustments) of this document for instructions on how to modify these curves.

Upshift/Downshift Tuning Notes:

- All Upshift points must occur at a higher speed than downshift. The touchscreen will give a warning and not allow this to occur if requested.
- Although it can be programmed with the handheld, the ECU won't allow a downshift to occur if it will over-rev the past the MAXIMUM RPM in the SYSTEM>TRANSMISSION>TRANS SETUP area.

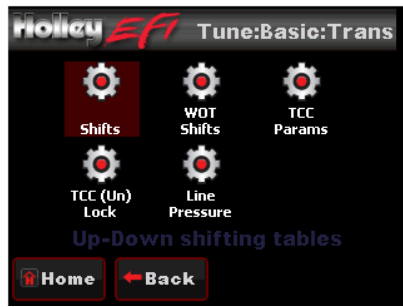

Figure 109



Figure 110



Figure 111

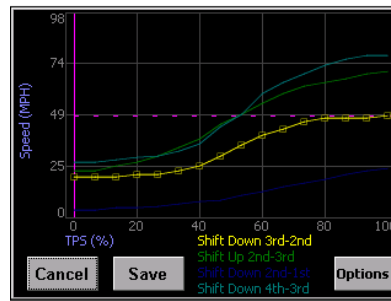

Figure 112

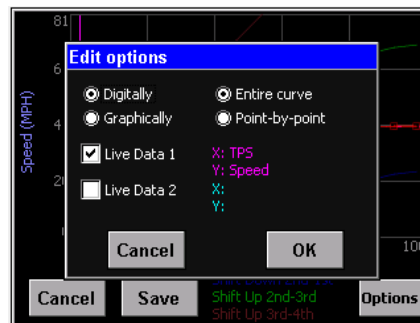

Figure 113

31.5.2 WOT Shifts

Use this menu to choose the RPM at which the transmission will upshift at WOT. Each gear change may be adjusted independent of the others.



Figure 114

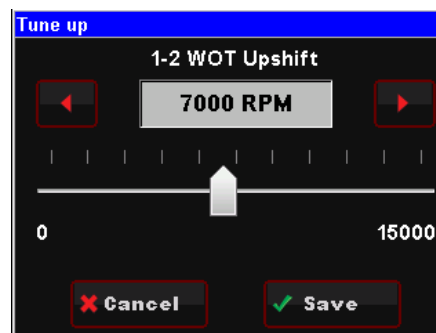

Figure 115

31.5.3 Torque Converter Clutch (TCC) Parameters

Contains parameters that tune TCC activation and deactivation.

- **Minimum RPM to Enable TCC** - Minimum engine speed at which the TCC will apply. This value can be adjusted so that engines with large camshafts do not hesitate surge if the TCC is applied at too low of an engine speed.
- **RPM to Disable TCC** - Used to unlock the TCC once it is locked. The Lock and Unlock values should not be too close together, or they will continuously lock and unlock. Applications with high stall torque converters will typically need 400-700 RPM or more between these values.

- **Maximum TPS TCC** - Throttle position value when the TCC will unlock. Most lockup torque converters do not have a clutch designed to lock up when higher power is being applied. It is best to unlock the converter under moderate to hard acceleration. Typically TPS values should be between 25-50%.
- **TCC Disable** - When enabled, the TCC will never lock up.

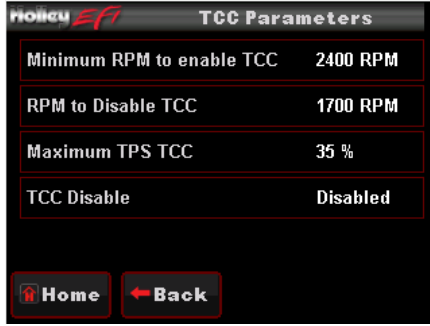

Figure 116

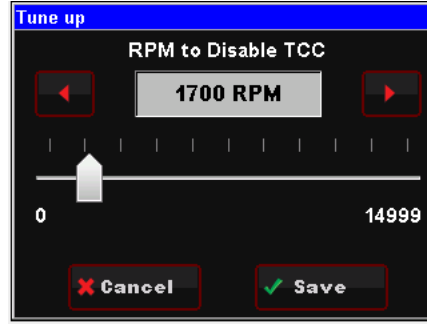

Figure 117



Figure 118

31.5.4 Torque Converter Clutch (TCC) (Un) Lock

These parameters work in addition to the TCC Parameters by offering additional tuning based on vehicle speed. This keeps the TCC from locking up during 'around-town' driving if it is not desired. The Lock values should always be higher than the Unlock values. Adjustments to these can be done by using the graph.

NOTE: See instructions for changing data in the GRAPH screen in the 'Making Adjustments' section 18.1.

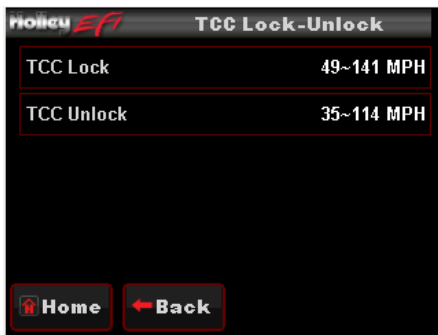

Figure 119

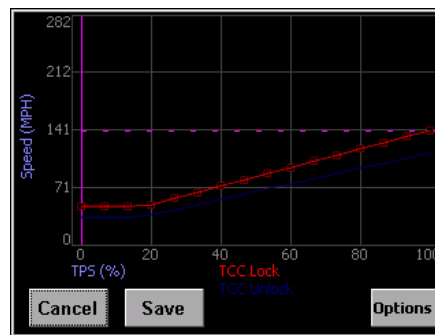

Figure 120

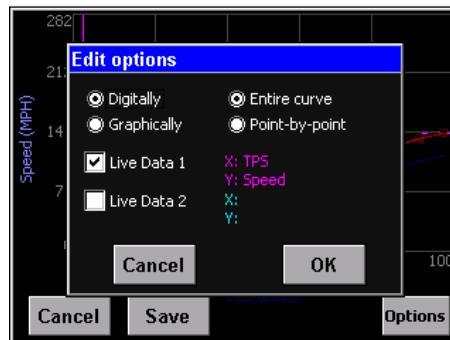

Figure 130

31.5.5 Line Pressure

Tune the line pressure vs. TPS or MAP for each gear. A lower duty cycle (moving towards 0%) increases line pressure with 0% providing maximum line pressure applied. Values above 40-50% typically result in a line pressure too low for any throttle position, which may result in transmission damage.



Figure 131

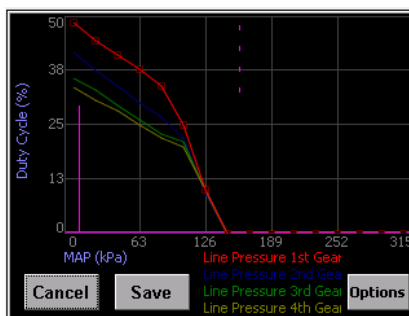

Figure 132

31.6 Drive-By-Wire

31.6.1 Pedal vs Throttle

The Pedal vs. Throttle Position table is the primary method of “tuning” a Drive-By-Wire throttle body system. The “Pedal Position” represents the position of the accelerator pedal. The user can adjust the “Throttle Position” to change based on the pedal position. This allows the user to increase or decrease throttle body position (engine airflow) to tailor the “responsiveness” of the engine. It can allow for an overly-large throttle body to have good driving manners or a small throttle body to be very responsive.

CAUTION: Take care when tuning the “Pedal vs. Throttle Cable”. When you increase the Pedal Position value at a certain TPS voltage, the throttle WILL go to that position at that TPS voltage setting. It is extremely important that you pay close attention and are not distracted when making changes to the “pedal vs. throttle cable” curve with the touch screen. Any changes to this curve should be made with the system OFFLINE and not while the engine is running and online. The curve of this graph should always be low at low (idle) pedal position and increase to fully open at high pedal positions. If you do not FULLY understand this graph, do NOT attempt to make any changes to the system. Locate a knowledgeable installer/tuner or contact Holley Performance Technical Service for assistance. The first data point in this table is limited to a value of 20%, the second cell 30%, and the fourth cell 40%. All other cells allow for the throttle body to be commanded to 100% throttle body opening.

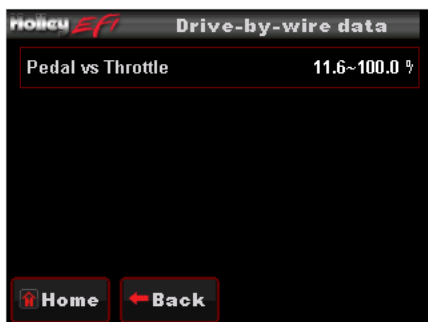

Figure 133

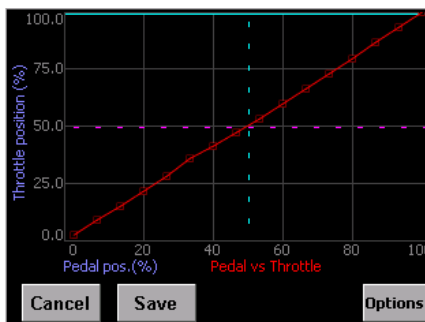

Figure 134

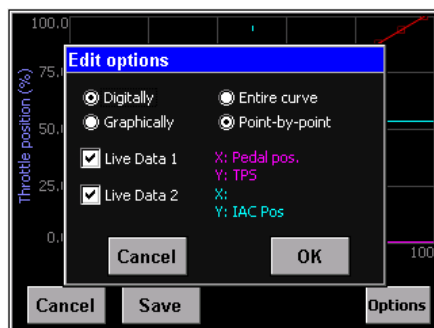

Figure 135

32.0 SYSTEM SETUP

32.1 System Tuning

From the HOME MENU, select TUNING, and SYSTEM. There are four areas you can modify; OUTPUTS, ENGINE SETUP, IGNITION SETUP, and TRANSMISSION.

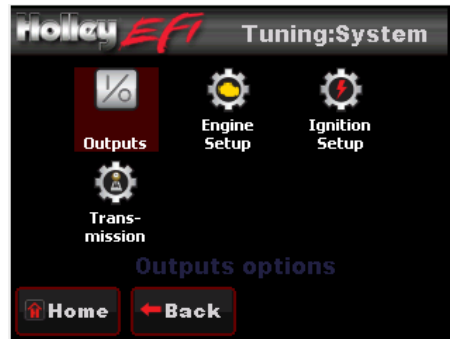

Figure 136

32.1.1 Outputs

The OUTPUT screen allows for the Fan #1 and Fan #2 ON and OFF temperatures to be adjusted. The ON temp needs to always be a higher value than the OFF temp. Use a difference of at least 5 degrees so they aren't cycling excessively. In Terminator Kits these are ground outputs that should be wired to trigger the fan relays. NEVER wire them directly to the fans! The AC Disable value is a TPS value above which a 12 volt output is sent out to deactivate the air conditioning compressor at wide open throttle.

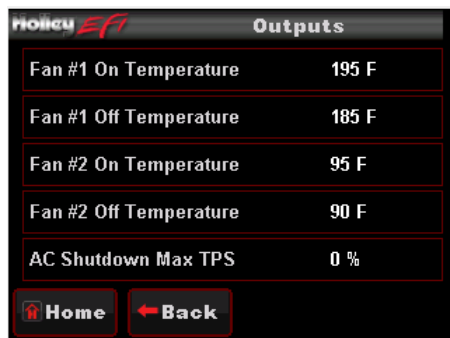

Figure 137

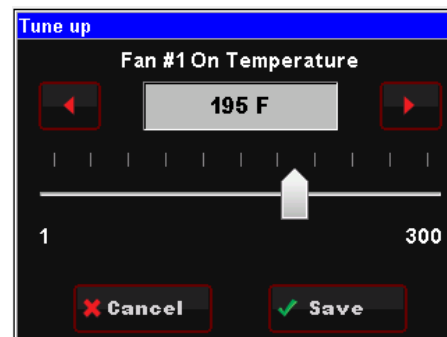

Figure 138

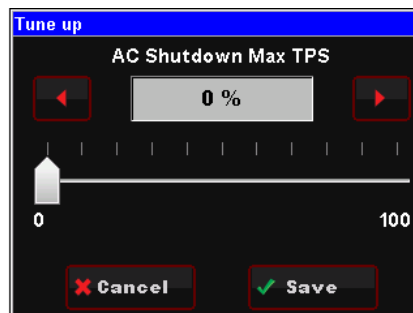

Figure 139

32.1.2 Engine Setup

These parameters should all be properly pre-set when you went through the Wizard process. If you change something on your engine, or run a different system fuel pressure or injector size, they can be edited here.

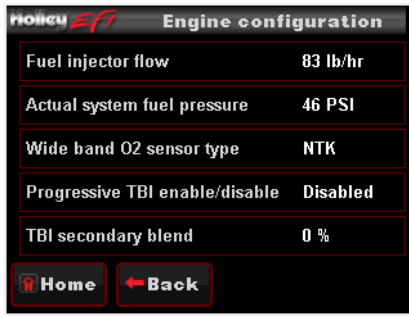

Figure 140

Fuel Injector Flow: Adjust fuel flow injector ratings to match what is installed on the engine

Actual System Fuel Pressure: Enter the actual fuel system pressure for accurate fuel map & logging data.

Wide Band O2 Sensor Type: Selects the type of wide band oxygen sensor used. If the software selection does not match the sensor being used damage to the WBO2 sensor will occur.

Progressive TBI Enable/Disable: This should be selected if using a TBI throttle body with progressive throttle linkage. All 4 BBL TERMINATOR™ TBI systems do NOT have progressive linkage, so this should not be checked. This will NOT be shown if you have selected a MPFI application.

TBI Secondary Blend: If using a TBI with progressive linkage, this value is used to start the ramp-in of the secondary fuel injectors as the rear throttle plates open. Enter the TPS when the rear throttle plates start to open. This is typically 36% for a Holley throttle body unit. The "Check for Progressive Throttle Linkage" must be checked for this box to be enabled. This will NOT be shown if you have selected a MPFI application

NOTE: Holley MPFI and TERMINATOR™ injector size/flow is calculated at 43 PSI.

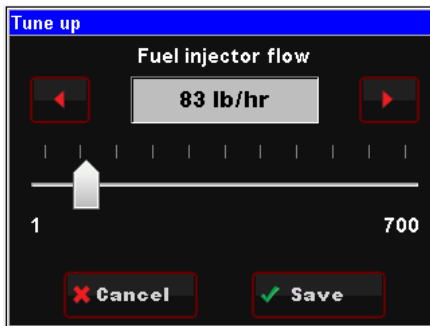

Figure 141



Figure 142



Figure 143

32.1.3 Ignition Setup

There are two parameters that are adjustable in the IGNITION SETUP. Ignition input type and engine rev limiter.

REV LIMIT – The rev limiter is only enabled when using a computer controlled small cap GM HEI. It is an ignition-only rev limiter. It will not shut fuel off. Enter a value for which you'd like the rev limiter to start.

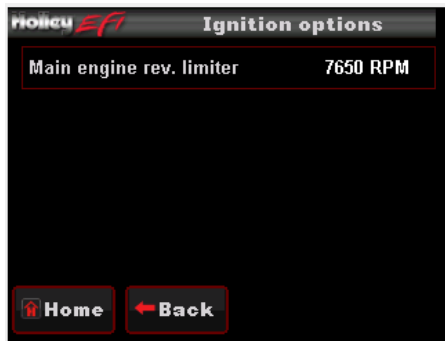

Figure 144

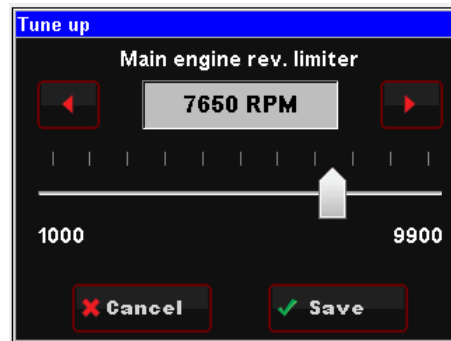

Figure 145

NOTE: MPFI and TERMINATOR™ injector size/flow is calculated at 43 PSI. TBI injector size/flow is calculated at 21 PSI.

33.0 ADVANCED TUNING

From the HOME MENU, select TUNING, and ADVANCED. There are four areas you can modify; ADV FUEL, CLOSED LOOP, ADV. LEARN, AND ADV. IDLE. These are reviewed below.

The Advanced Tuning areas typically won't ever be needed to be changed. However, after getting used to the TERMINATOR™ EFI system, there may be some fine tuning of various parameters that you'd like to perform.



Figure 146

33.1 Advanced Fuel

- **Coolant Enrichment:** Coolant enrichment is similar to the choke on a carburetor. Adjustments are made as a percentage of the base map from 100% to 150%. 100% would mean no additional fuel is being added by the Coolant Enrichment, 110% would mean that an additional 10% of fuel is being added to the base fuel map which will decay back to 100% in relation to actual engine coolant temperature.
- **Load Based Acceleration Enrichment:** This parameter provides another way of adding fuel when the accelerator is depressed. It adds fuel depending on how fast the MAP sensor reading changes (detects a change in engine load). There is typically no need to adjust this parameter except possibly under some extreme conditions of vehicles that are heavy and under-powered. Adjustment values are in pounds of fuel per hour (pph) and should initially be adjusted in increments of 5-10 pph
- **Cranking Fuel:** This dictates how much fuel is injected when the engine is cranking and is dependent on coolant temperature. Changing this value offsets the entire curve at all temperatures. Adjustment values are in pounds of fuel per hour (pph) and should initially be adjusted in increments of 2-4 pph.
- **Afterstart Fuel:** The afterstart parameter is fuel that is added for a short time immediately after an engine starts. This value varies depending on engine temperature. Changing this value offsets the entire curve at all temperatures. Adjustments are made as a percentage of the base map from 75% to 200%, 100% would mean no additional fuel is being added, 110% would mean that an additional 10% of fuel is being added to the base fuel map, and 85% would mean that 15% of fuel is being taken away from the base map. All selections will decay back to 100% over a predetermined amount of time.

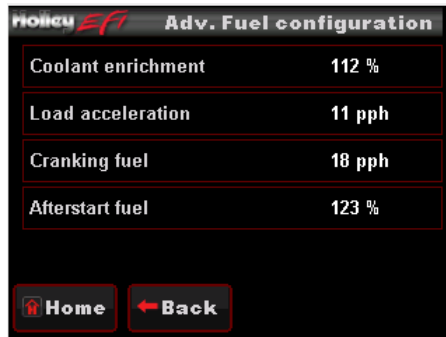

Figure 147

33.2 Closed Loop

CLOSED LOOP OPERATION relies on WBO2 sensor readings. The Holley EFI system uses these readings to analyze 'real time' running conditions. The data obtained by the ECU is then used trim fuel flow to achieve the targeted air fuel ratio (AFR).

Choosing CLOSED LOOP from the ADVANCED TUNING menu will allow you to modify four areas of the CLOSED LOOP operation.

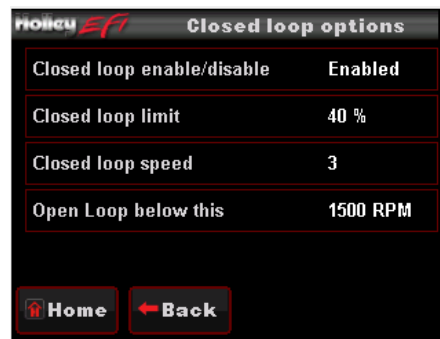

Figure 148

- **Closed Loop Enable/Disable:** This menu enables or disables closed loop operation. There is typically no reason to turn off closed loop operation unless you suspect an oxygen sensor problem and want to disable the sensor. **Note:** Self-Tuning requires closed loop operation to function.
- **Closed Loop Limit:** The maximum percentage the ECU is allowed to deviate (+/-) from the base fuel calibration in order to maintain the commanded target air fuel ratio. This is set to 100% by default and under most circumstances should not need to be changed.
- **Closed Loop Speed:** This is the "speed" (gain) at which closed loop operation occurs. This can be set to five levels, 1, 2, 3, 4, or 5. 3 is the base setting and should be good for most applications. 4 or 5 is typically not used as the closed loop speed may be too excessive for certain applications. If the oxygen sensor is installed far back in the exhaust (more than 1 foot back from the collector in long tube headers), a value of 1 or 2 may be needed.
- **Open Loop Below This:** This setting is usually zero. If an extremely large camshaft is used (specs only typically found on race camshafts), the overlap sometimes causes a "false lean" reading at low RPM. In these cases, it may be required to put in a value of 1500-2000 RPM so the system operates open loop below this RPM setting.

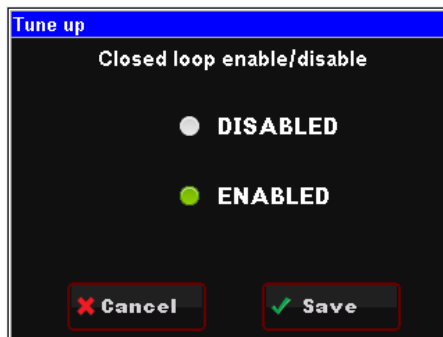

Figure 149

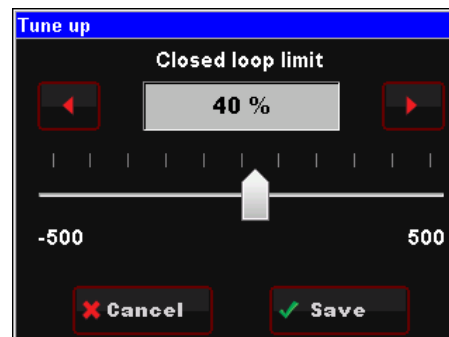

Figure 150

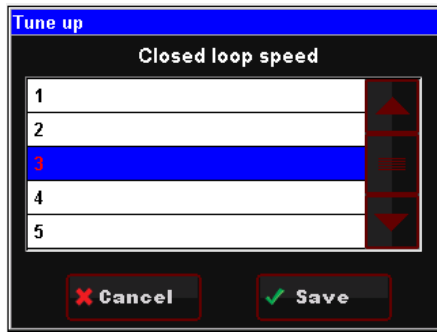

Figure 151

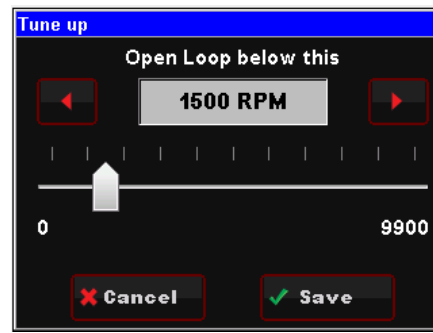

Figure 152

33.3 Advanced Learn

Choosing ADVANCED LEARN will allow you to modify the LEARN COMPENSATION LIMITS. This value is set to 100% by default, and should remain there until ample driving time and tuning has occurred. The LEARN COMPENSATION LIMIT is a parameter that ECU is allowed to work within when making changes to the fuel map based upon CLOSED LOOP operation. Unlike the CLOSED LOOP LIMIT which is a set parameter for commanded changes to actual fuel flow based upon the O2 sensor reading, LEARN COMPENSATION LIMITS are the percentage of change that is allowed to actually be saved as a modifier to the fuel map.



Figure 153

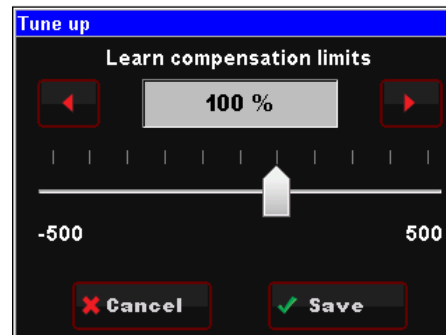

Figure 154

33.4 Advanced Idle

The ADVANCED IDLE parameters adjust specific characteristics of how the idle air control motor functions on engine decel and startup.

Selecting ADVANCED IDLE brings up the following menu:



Figure 155

33.4.1 IAC Rampdown

The Idle Air Control (IAC) motor is a stepper motor located in the throttle body that controls the idle speed of the engine by metering air. It also operates during engine cranking and when the engine returns back to idle. The following settings can adjust how that functions. The IAC moves from a position of 0% (fully closed, no air added) to 100% (fully open, maximum air flow).

NOTE: Contact Holley Tech Support if you have any questions regarding IAC settings.

Selecting IAC RAMPDOWN brings up the following menu with four choices, IAC HOLD POSITION, IAC RAMP DECAY, IAC RAMP START, and IAC KICK. These are reviewed below:

- **IAC Hold Position:** This is the position the IAC motor will “hold” or “freeze” at when the TPS moves above idle (when TPS becomes greater than 0%). If it is too high, the engine RPM will “hang” and not return to idle.
- **IAC Ramp Decay:** This is the time (in seconds) it takes for the IAC to decay from the “IAC Hold Position” back to a “0%” position. It is a linear decay.
- **IAC Ramp Start (RPM above idle):** This value is the RPM added to the target idle speed that the IAC will automatically start to ramp back down to idle. If this is too low, the engine RPM will “hang” and not return to idle.
- **IAC Kick:** The IAC Kick provides a temporary increase in IAC position to keep engine the RPM from dropping. Typically this is used in conjunction with an A/C system keep the engine speed from ‘dipping’ as the compressor cycles on and off.

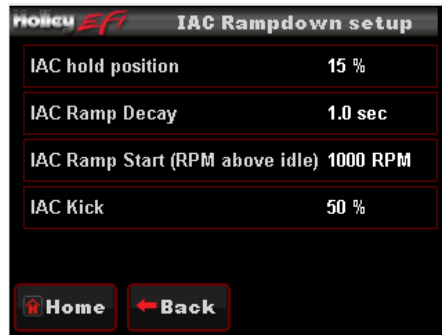

Figure 156

33.4.2 IAC Speed

This menu is used to select the type of IAC motor application that is being used. This selection drives the background parameters that control the IAC motor. These parameters have been fine tuned for each of these applications, eliminating the need for the user to perform further modifications

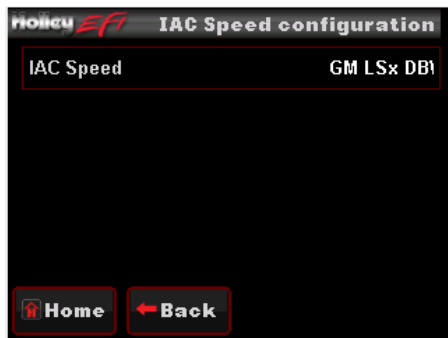

Figure 157

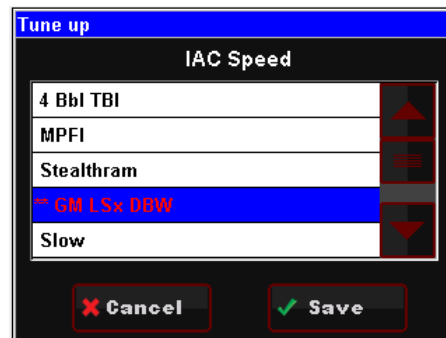

Figure 158

33.4.3 IAC Startup

These parameters control the position of the IAC when the engine is cranking and immediately after it starts.

Selecting IAC STARTUP brings up the following menu with three choices, IAC PARKED POSITION (CRANKING), IAC STARTUP HOLD TIME, and IAC STARTUP DECAY TIME.

- **IAC Parked Position (Cranking):** This is the position the IAC motor will be at during cranking and immediately after the engine starts. If it is too high, the engine will be at too high of an RPM once it starts. Too low and poor starting will result. Note that this is a temperature based table. The percentage value changed in the handheld offsets this entire curve.
- **IAC Startup Hold Time:** This is the amount of time that the IAC will remain at the “IAC Parked Position”.
- **IAC Startup Decay Time:** This is the amount of time for the IAC to decay from the “IAC Parked Position” back to its “Target Idle” position. It is a linear decay.



Figure 159

33.4.4 Idle Spark

Idle spark is a feature active only when the ECU is controlling timing. When enabled, the ECU modifies commanded timing at idle to help maintain the target idle speed.

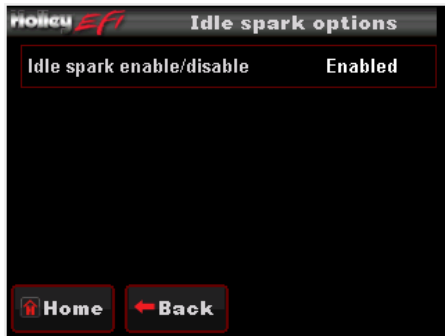

Figure 160

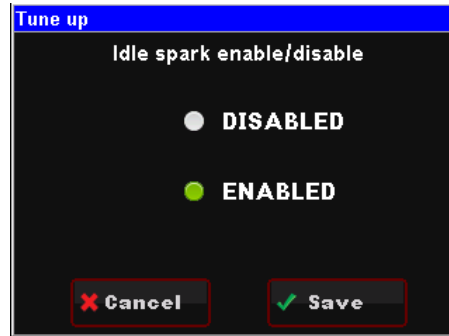

Figure 161

NOTE: This feature should be disabled when checking base timing with a timing light! If not disabled rev the engine to approximately 2000 RPM when syncing timing.

APPENDIX 2.0 INJECTOR GROUPINGS AND INJECTOR CONNECTOR INFORMATION

Injector Groups

Using the OEM or AC Delco part number found on the side of your injectors, determine which injector group to choose from the Calibration Wizard (Section 20.0, Figure 57)

Group 1

- Connector Type: Multec 2
- Year Range: 2000 thru 2007 4.8-6.0L Trucks
- VIN Codes: B, N, P, T, U, V, Z
- Engine Codes: L33, L59, LM4, LM7, LQ9, LR4, & LQ4 (truck)
- Injector Part Numbers:
 - 25317669
 - 25320287
 - 25317628
 - 25317670
 - 25320288
 - 25323974
 - 17113553
 - 17113698
 - 17113582

Group 2

- Connector Type: USCAR / EV6
- Year Range: 2005 thru 2009 4.8-6.0L Trucks
- VIN Codes: 5, 8, C, H, J, K, L, M, Y
- Engine Codes: L76, L92, LFA, LH6, LS2, LY2, LY5, LY6
- Injector Part Numbers:
 - 12580681
 - 217-1621

Group 3

- Connector Type: USCAR / EV6
- Year Range: 2002 thru 2007 5.3L Flex Fuel & 2009+ 4.8-7.0L
- VIN Codes: 0, 3, 4, 7, A, E, H, J, K, P, U, W, Y, Z
- Engine Codes: L20, L59, L76, L99, LC9, LH9, LMF, LMG, LS3, LS7, LY5, LY6, LZ1, & LQ4 (car)
- Injector Part Numbers:
 - 12587269
 - 89017586
 - 25326903
 - 12580426
 - 12613411
 - 12594512
 - 12576341
 - 217-3347
 - 217-1627
 - 217-1626
 - 217-3411
 - 217-2436
 - 217-2425
 - *522-428 - HOLLEY 42 LB/HR (EV1 connector)

Group 4

- Connector Type: USCAR / EV6
- Year Range: 2009+ 6.0L & 6.2L Trucks
- VIN Codes: 2, B, F, G
- Engine Codes: L94, L96, L9H, LC8
- Injector Part Numbers:
 - 12609749
 - 12613412
 - 217-3410
 - 217-3412

Group 5

- Connector Type: EV1
- Year Range: 1997-2005 5.7L
- VIN Codes: G, S
- Engine Codes: LS1 & LS6
- Injector Part Numbers:
 - 12554271
 - 12482704
 - 12533952
 - 217-1528

Injector Connectors

There are three variations of LS injector connectors:

EV1

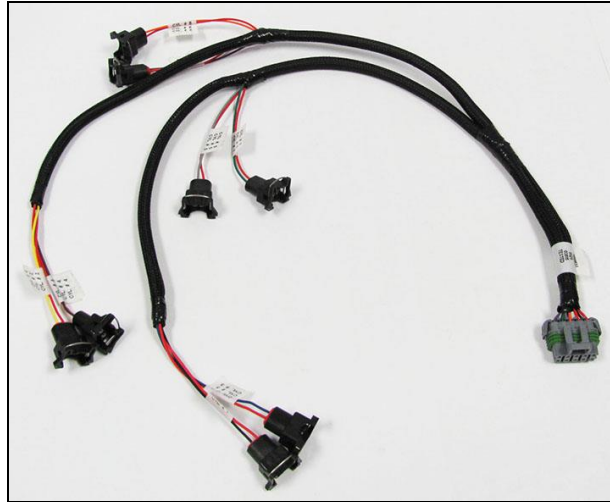

Service item # 558-200

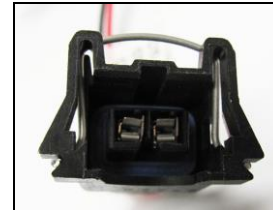
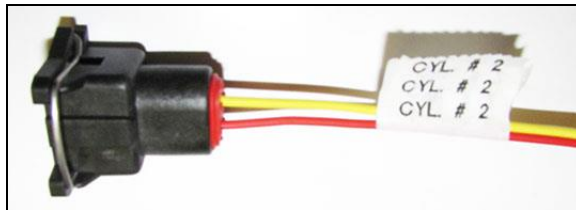

EV6 / USCAR

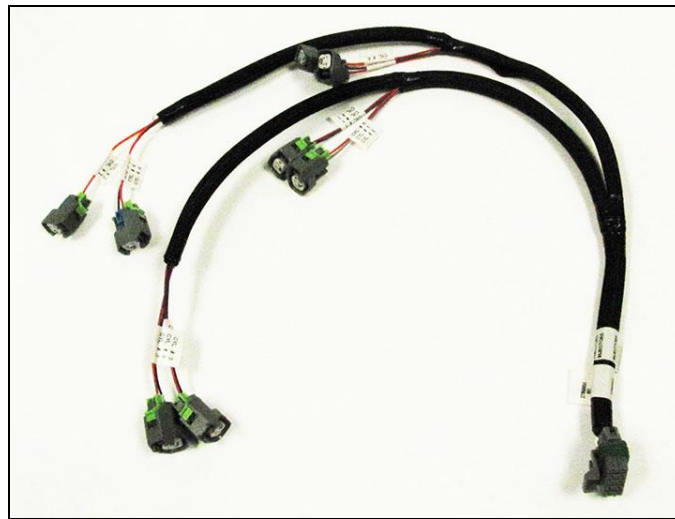

Service item # 558-201

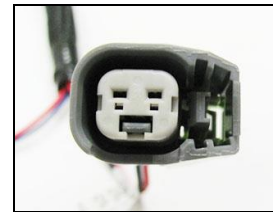
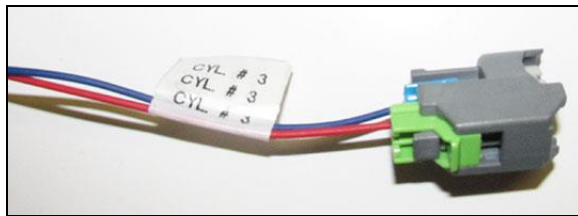

MULTEC 2

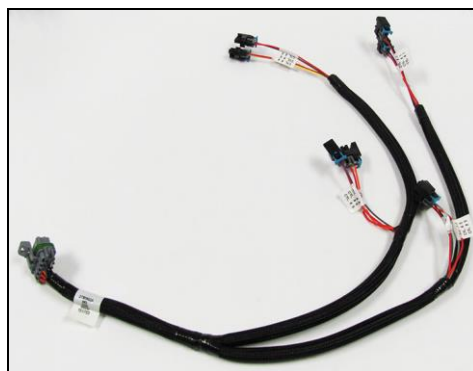

Service item # 558-214

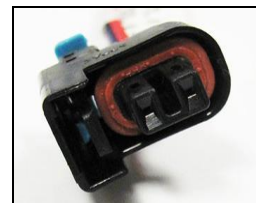
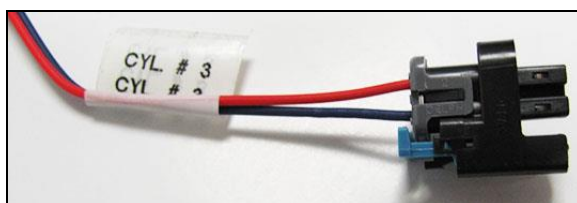

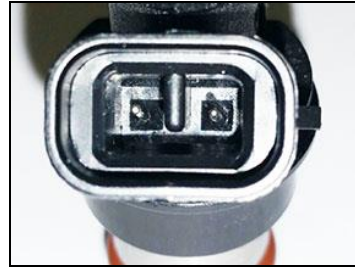

APPENDIX 3.0 THROTTLE BODIES AND PEDALS

There are two styles of DBW throttle body connectors. The following part numbers are supported by Holley Terminator MPFI kits:

6 PIN CONECTOR:

Service item # 558-406



Service item # 558-406

- 12570790
 - 2005-2008 Corvette, CTS-V and GTO
 - VIN Codes: E, U, W, Y
 - Engine Codes: L76, LQ4 (car), LS2, LS3, LS7
- 12580760
 - 2005-2008 Truck
 - VIN Codes: 0, 3, 4, 5, 8, C, H, J, K, L, M, Y
 - Engine Codes: L76, L92, LC9, LFA, LH6, LMF, LMG, LS2, LY2, LY5, LY6
- 12605109
 - 2009-2013 Corvette, Camaro, G8
 - VIN Codes: E, J, W, Y
 - Engine Codes: L76, L99, LS3, LS7
- 12629992
 - 2009+ Truck
 - VIN Codes: 0, 2, 3, 4, 5, 7, 8, A, B, C, F, G, H, J, K, L, M, P, Y
 - Engine Codes: L20, L76, L92, L94, L96, L9H, LC8, LC9, LFA, LH6, LH8, LH9, LMF, LMG, LS2, LY2, LY5, LY6, LZ1
- 17113669
 - 2001 thru 2005 Corvette & CTS-V
 - VIN Codes: G, S
 - Engine Codes: LS1, LS6

8 PIN (EARLY TRUCK) CONNECTOR:



- 12570800
 - 2002-2007 Truck
 - VIN Codes: B, N, P, T, U, V, Z
 - Engine Codes: L33, L59, LM4, LM7, LQ4 (truck), LQ9, LR4

Throttle Pedal

Holley recommends GM P/N - 10379038 which is a passenger car pedal with a 6 pin connector.

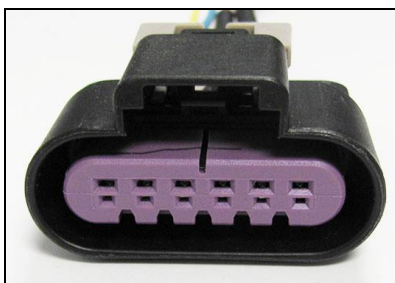

APPENDIX 4.0 SENSOR DIAGNOSTICS AND STATUSES

Sensor diagnostics are included in the handheld. If one of the main sensors has some type of error, a small, blinking red circle will appear in the upper right of the screen. To navigate to the diagnostics, select MONITOR and DIAGNOSTICS. If there is an issue an error will also be shown on any of the MONITOR or GAUGES screens.

Wideband Oxygen Sensor Status – Shows status of wideband oxygen sensors.

Text	Description
...	Signifies that sensor channel is not enabled.
Init..	First shown for an instant when the system is powered on. Displayed so quickly you will likely not see this.
Heating	Sensor is heating.
Cold!	Sensor is below calibrated operating temperature. Unit will still read but accuracy may be impacted.
Hot!	Sensor is above calibrated operating temperature. Unit will still read but accuracy may be impacted.
Unplgd	Sensor is unplugged.

General Sensor Status – These are shown for the coolant and air temperature, MAP, TPS, Oil and Fuel pressure sensors. If you do not have an oil or fuel pressure sensor installed, you will see this error. It will not cause a problem.

Text	Description
Undefnd	Unlikely failure indicated that a sensor is not properly defined.
LOW Err	A sensor displaying this can be unplugged, have an open or short circuit, or be otherwise damaged.
HI Err	A sensor displaying this can be unplugged, have an open or short circuit, or be otherwise damaged.

RPM (Crank Signal Inputs) Diagnostics – The following are shown for the “RPM” parameter which indicates the status of the crank sensor/engine speed input.

Text	Description
Stall!	No RPM input detected.
Syncng	Signal detected. Position being established.
Nothing	Will show briefly after crank signal and cam/crank positions established. Actual engine RPM will then be indicated.
Error!	Cam/Crank input error detected.

TPS Diagnostics – The following are shown for the “TPS” parameter.

Text	Description
Error!	If you see an error, contact Holley Tech Service.
NeedCal	TPS Autoset needs to be performed.

Closed Loop Diagnostics – Shows status of closed loop operation.

Text	Description
OpenLp	System is in open loop operation.
CloseLp	System is in closed loop operation.

Learn Status – Shows status of learn mode.

Text	Description
NoLearn	Learning is not active.
Learnng	Learn is in an active state.

Switched Inputs/Outputs Status – Shows status of switched inputs and outputs.

Text	Description
OFF	Input or Output is not active.
ON	Input or Output is active.

271R968A
LS1 MAIN HARNESS
 (HARNESS ONLY SALES P/N 558-102)

DESCRIPTION	COLOR	WIRE GAUGE	PIN #
COIL IN	YELLOW	22 ga	A1
FUEL PUMP RELAY OUT (10A MAX)	RED	22 ga	A2
INPUT #2 (F 5.2 T.H.G)	WHITE/RED	22 ga	A3
INPUT #4 (F 5.5)	WHITE/GREEN	22 ga	A4
TPS SIGNAL	GREEN	20 ga	A5
POINTS OUTPUT	WHITE	16 ga	A6
WBI COMP#2	PAN	20 ga	A7
WBI SHIELD	SHIELD	20 ga	A8
WBI HTR -	YELLOW	16 ga	A9
SWITCHED +12V IN	RED/WHITE	20 ga	A10
MAT INPUT	BLUE	22 ga	A11
INPUT #1 (F 5.2 T.H.G)	WHITE/BLUE	22 ga	A12
INPUT #3 (F 5.3)	WHITE/BLACK	22 ga	A13
FU GROUND	BLACK/SHIELD	22 ga	A14
DOG TX	WHITE/BLACK	22 ga	A15
WBI COMP#1	BROWN	20 ga	A16
WBI VS-IP -	BLACK	20 ga	A17
SENSOR GROUND OUT	BLACK/WHITE	22 ga	A18
COOLANT TEMP IN	BROWN	22 ga	A19
OIL PRESSURE	GREY	22 ga	A20
KNOCK #2 IN	BEIGE/RED	22 ga	A21
CAM INPUT (IG & IP)	PURPLE	22 ga	A22
MAP SENSOR SIGNAL	RED/BLACK	22 ga	A23
CAN LO	ORANGE	22 ga	A24
WBI VS+	RED	20 ga	A25
SENSOR-VV REF OUT	ORANGE	22 ga	A26
BYPASS OUT	BEIGE/BLACK	22 ga	A27
TACHOMETER	BLUE/WHITE	22 ga	A28
KNOCK #1 INPUT	BEIGE/BLUE	22 ga	A29
CRANK INPUT (IG & IP)	PURPLE	22 ga	A30
FUEL PRESSURE	PURPLE	22 ga	A31
CAN HI	ORANGE/BLACK	22 ga	A32
WBI VS+	WHITE	20 ga	A33
WBI HTR+	ORANGE	16 ga	A34

DESCRIPTION	COLOR	WIRE GAUGE	PIN #
IG A LO	PURPLE/BLUE	22 ga	B1
IG A HI	PURPLE/YELLOW	22 ga	B2
PWM #4 OUT (HG)	GRAY/GREEN	20 ga	B3
INJECTOR F	GREEN	20 ga	B4
INJECTOR G	ORANGE	20 ga	B5
INJECTOR H	BLUE	20 ga	B6
INJECTOR E	PINK	20 ga	B7
IG B LO	PURPLE/WHITE	22 ga	B8
IG B HI	PURPLE/BLACK	22 ga	B9
PWM #3 OUT (HG)	GRAY/BLACK	20 ga	B10
PWM #2 OUT (HG)	GRAY/RED	20 ga	B11
PWM #1 OUT (HG)	GRAY/YELLOW	20 ga	B12
INJECTOR D	PURPLE	20 ga	B13
EST GROUND OUT	BLACK/YELLOW	20 ga	B14
EST B	GREEN/WHITE	22 ga	B15
EST D	ORANGE/WHITE	22 ga	B16
EST F	BLUE/WHITE	22 ga	B17
EST H	PINK/WHITE	22 ga	B18
INJECTOR A	GRAY	20 ga	B19
EST TV OUT	RED	20 ga	B20
EST A	YELLOW/WHITE	22 ga	B21
EST C	GRAY/WHITE	22 ga	B22
EST E	LIGHT BLUE/WHITE	22 ga	B23
EST G	LIGHT GREEN/WHITE	22 ga	B24
INJECTOR C	BEIGE	20 ga	B25
INJECTOR B	WHITE	20 ga	B26

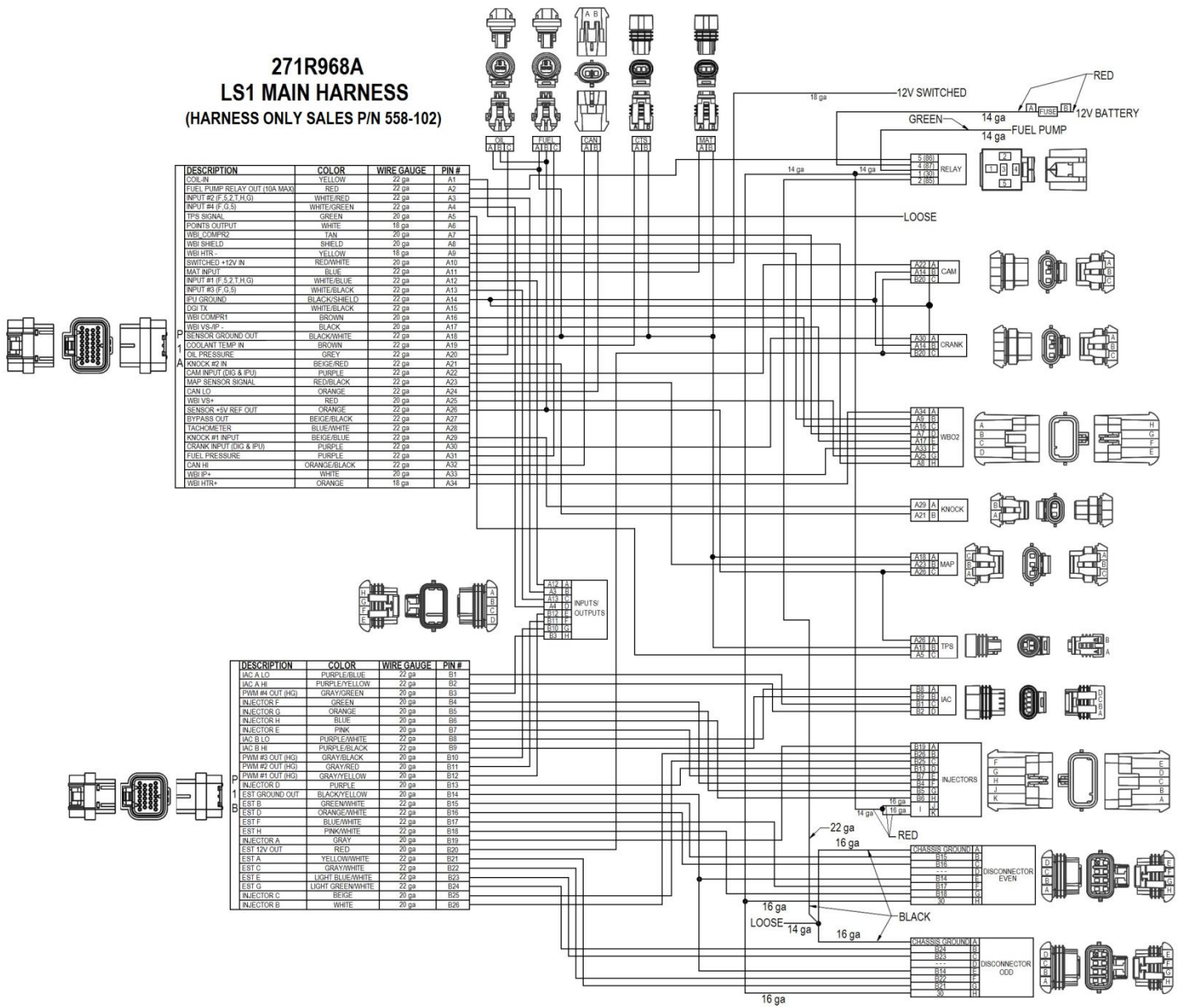

271R968A
LS1 MAIN HARNESS
 (WIRING HARNESS SALES P/N 558-102)

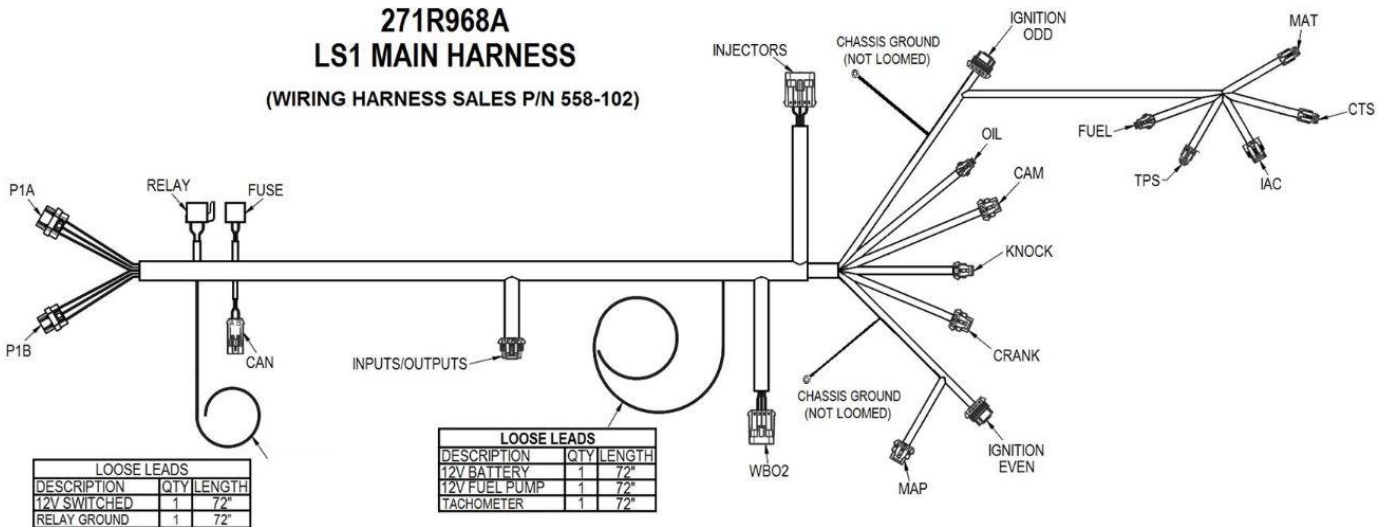

LOOSE LEADS		
DESCRIPTION	QTY	LENGTH
12V SWITCHED	1	72"
RELAY GROUND	1	72"

LOOSE LEADS		
DESCRIPTION	QTY	LENGTH
12V BATTERY	1	72"
12V FUEL PUMP	1	72"
TACHOMETER	1	72"

271R962A LS2 MAIN HARNESS (HARNESS ONLY SALES P/N 558-103)

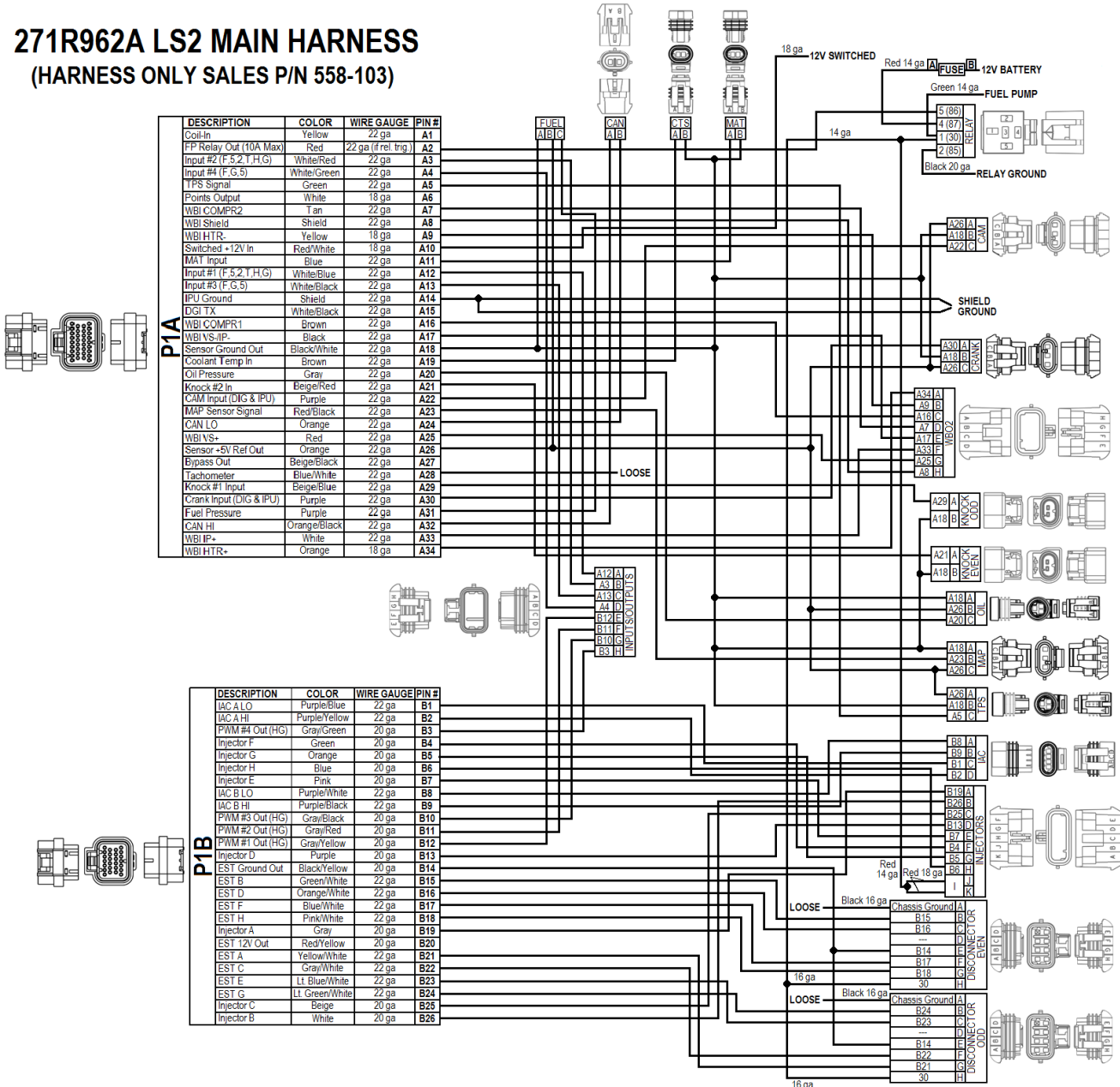

271R962A LS2 MAIN HARNESS (HARNESS ONLY SALES P/N 558-103)

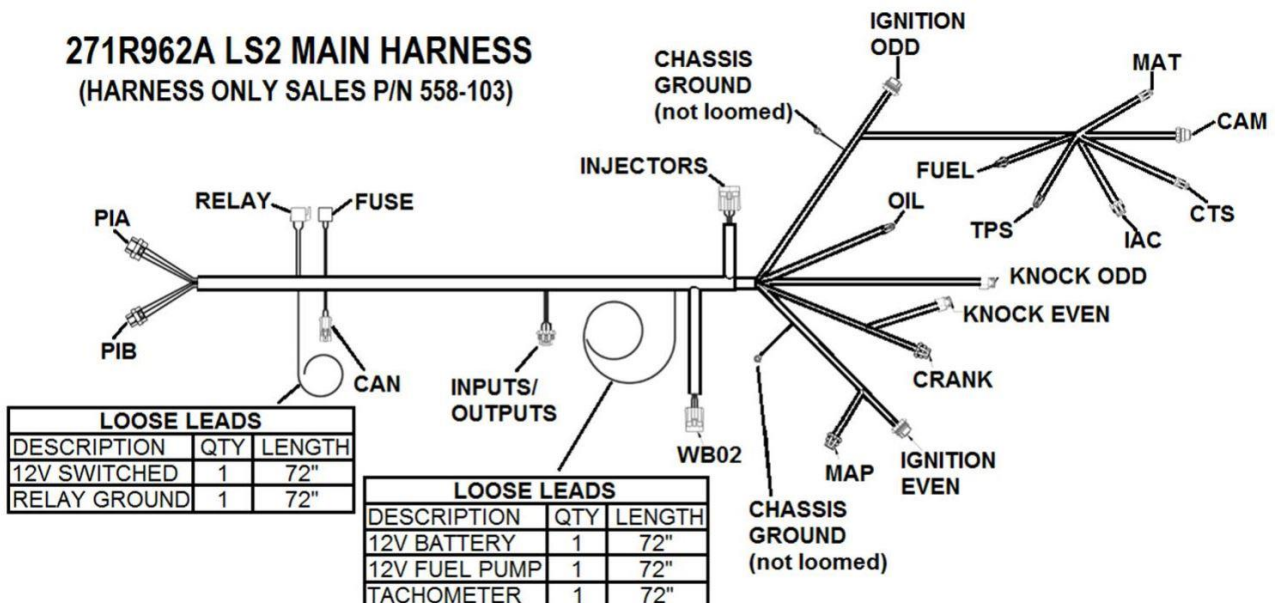

271R990A GM DRIVE-BY-WIRE HARNESS

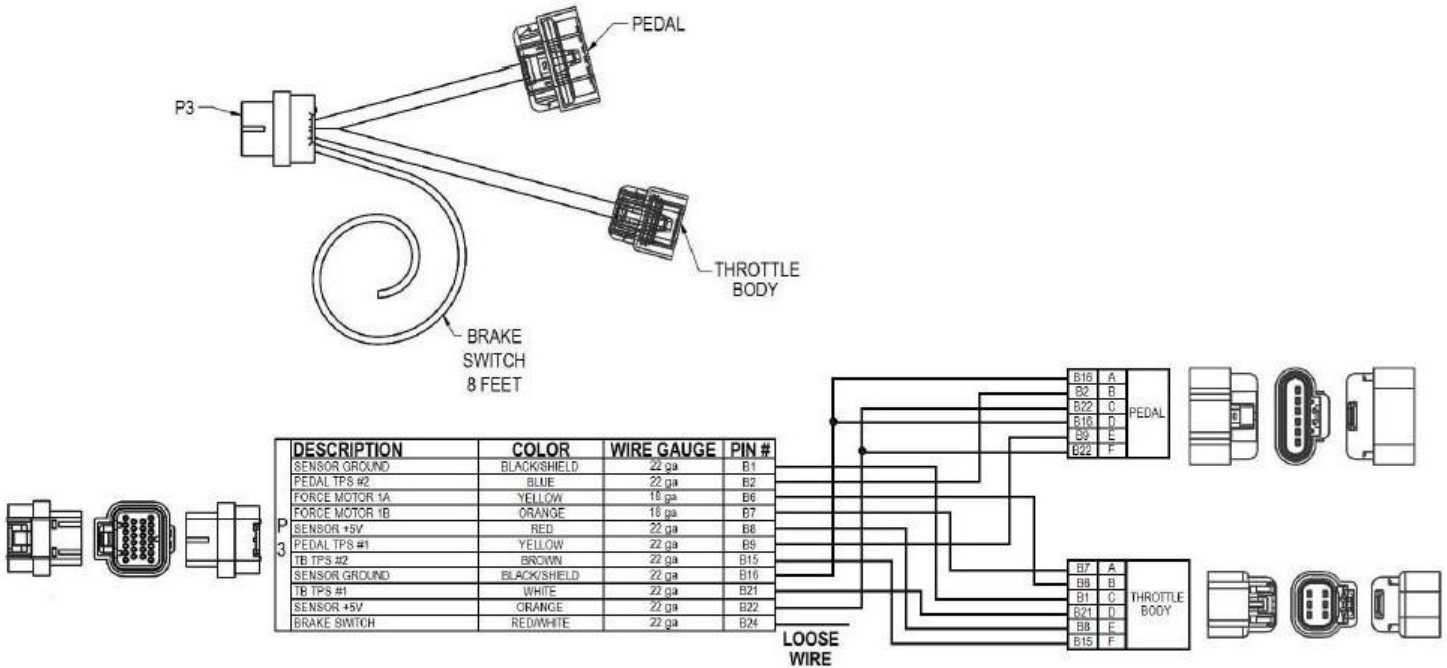

271R1101A – EARLY TRUCK DRIVE-BY-WIRE HARNESS

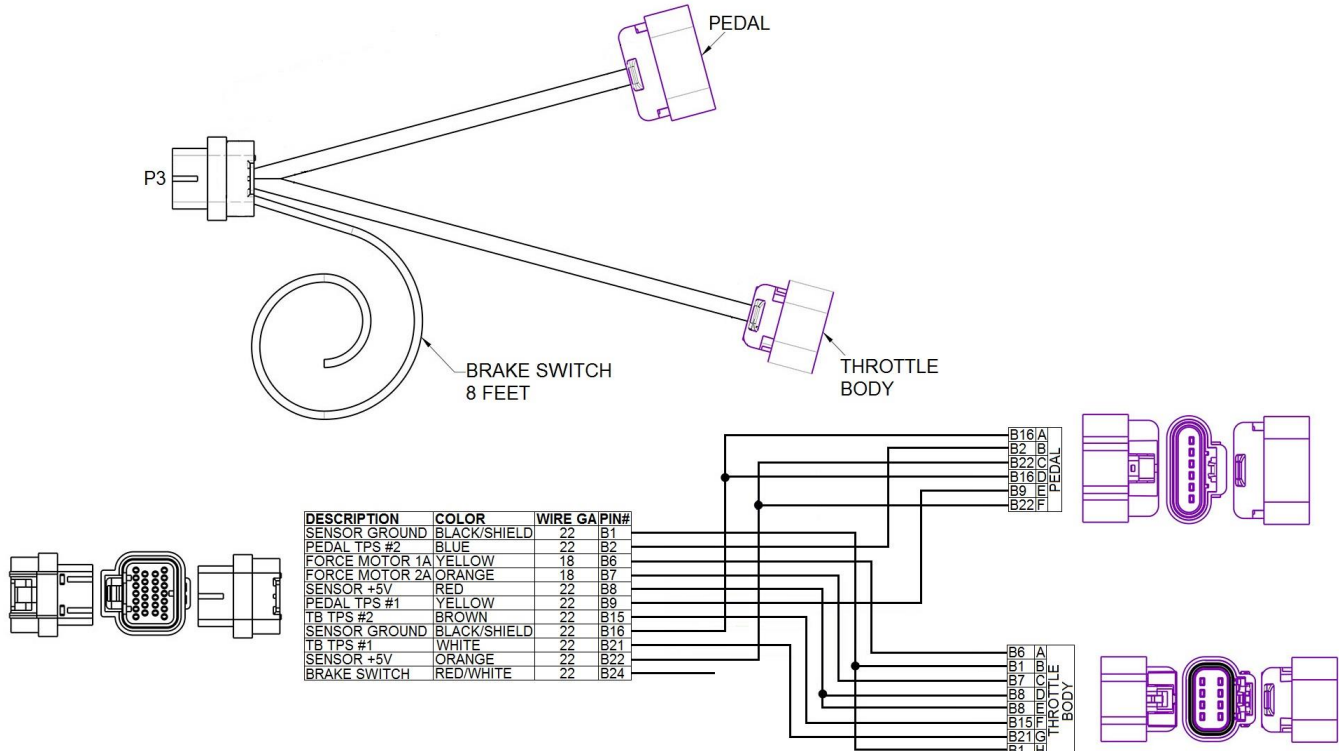

271R974A GM 4L60E-4L80E TRANSMISSION HARNESS

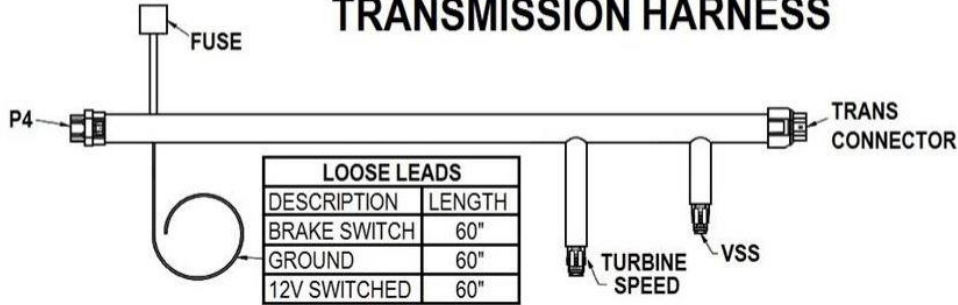

LOOSE LEADS	
DESCRIPTION	LENGTH
BRAKE SWITCH	60"
GROUND	60"
12V SWITCHED	60"

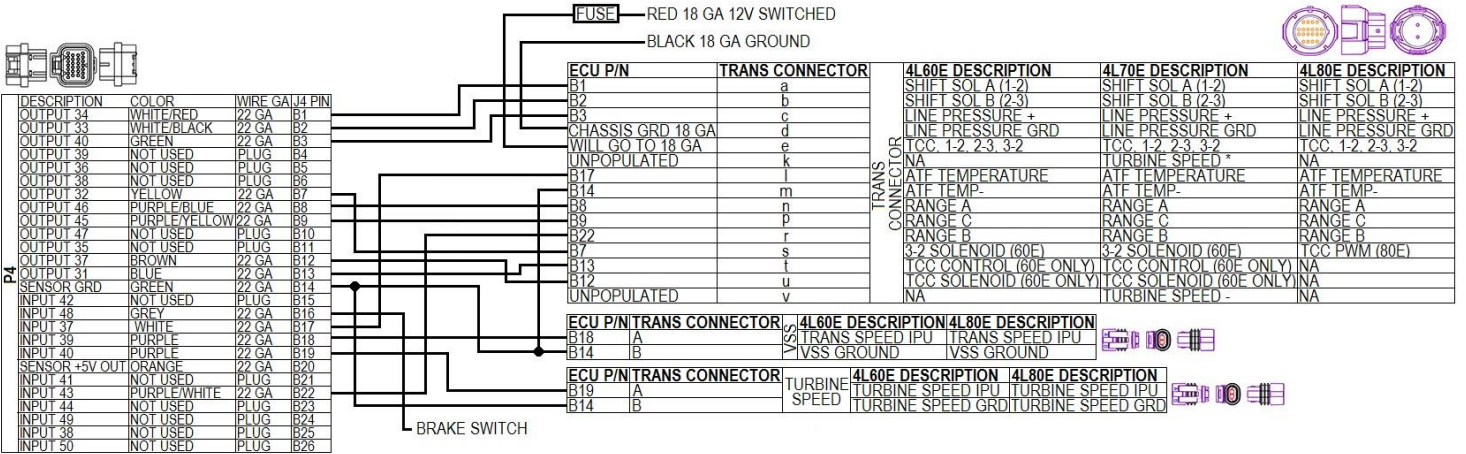

Holley Technical Support: 1-866-464-6553

© 2015 Holley Performance Products, Inc. All rights reserved.

199R10762
Revision Date: 8-20-15